





Tek-Bar 3110B



Quick Start Guide

1. Before You Begin

Before installation check the model, specifications, and installation location for the transmitter. Follow the Operating Instruction Manual for detailed installation and other information.

-  Do not remove the transmitter cover in explosive atmospheres when the circuit is live.
-  Before connecting a HART-based communicator in an explosive atmosphere, make sure the instruments in the loop are installed in accordance with appropriately safe field wiring practices.
-  Trained, qualified specialists must carry out installation of the device. The specialist must have read and understood these Operating Instructions and must follow the instructions they contain.
-  Do not clean or touch diaphragm seals with any hard or pointed objects.
-  When using the measuring device in hazardous areas, installation must comply with the corresponding national standards and regulations and the Safety Instructions, or Installation or Control Drawings.

2. Unpack

Tek-Bar 3110B Smart Differential Pressure Transmitter

3. Dimensional Drawings

Drawing /Dimension with Display

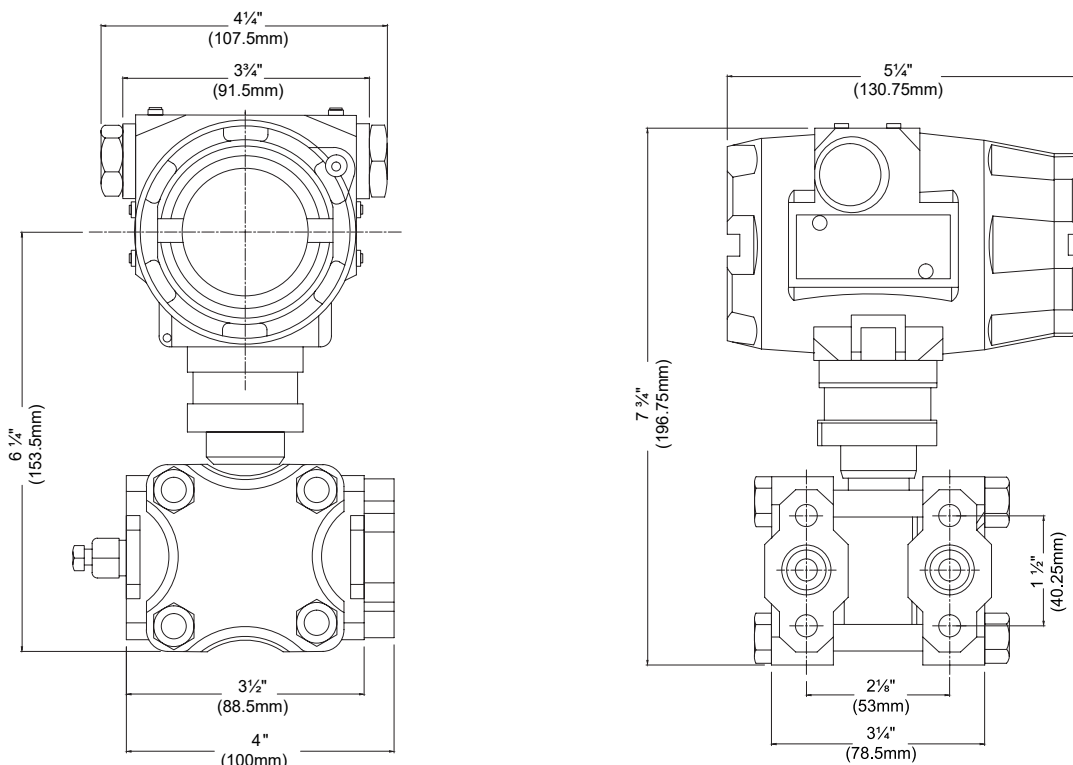

4. Mounting

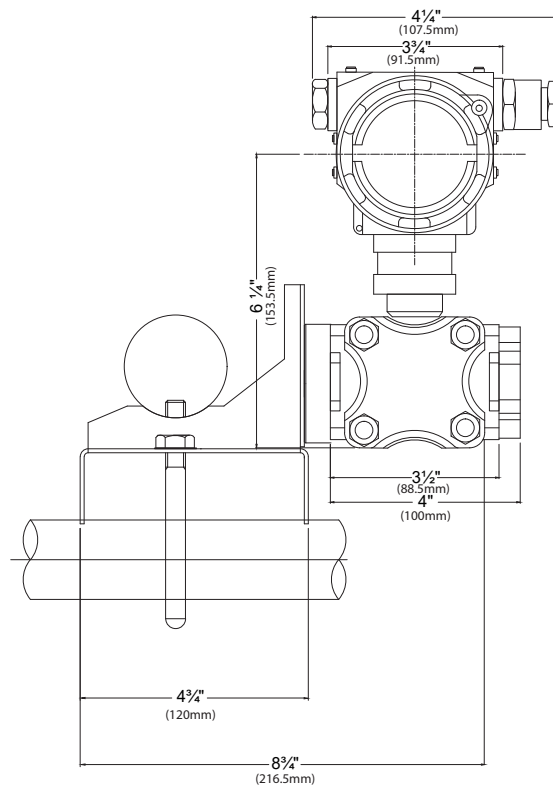

5. Display

The display module is used for field adjustment to complete the parameters settings and site configuration before measuring. The local display enables all of the important parameters to be read directly at the measuring point and to configure the device using the function matrix. It has 5-digit LCD display.



Quick Start Guide

6. Power Supply Wirings

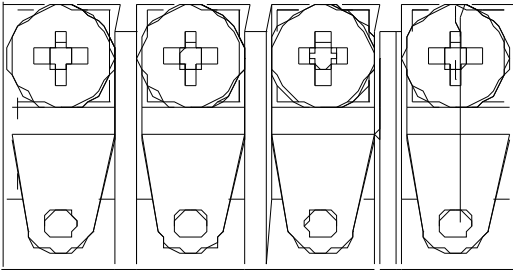

+ - A B

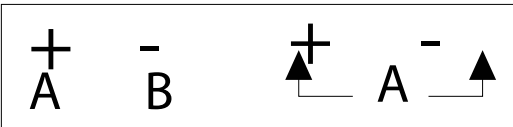

Label	Two Wires	Three Wires	Four Wires
+	Power +	Power +	Power +
-	Power -	Power -	Power -
A		Signal +	Signal +
B			Signal -

- ① Power supply+ is connected with transmitter terminals+
- ② Signal+ is connected with transmitter terminals-
- ③ Signal- is connected with power supply-

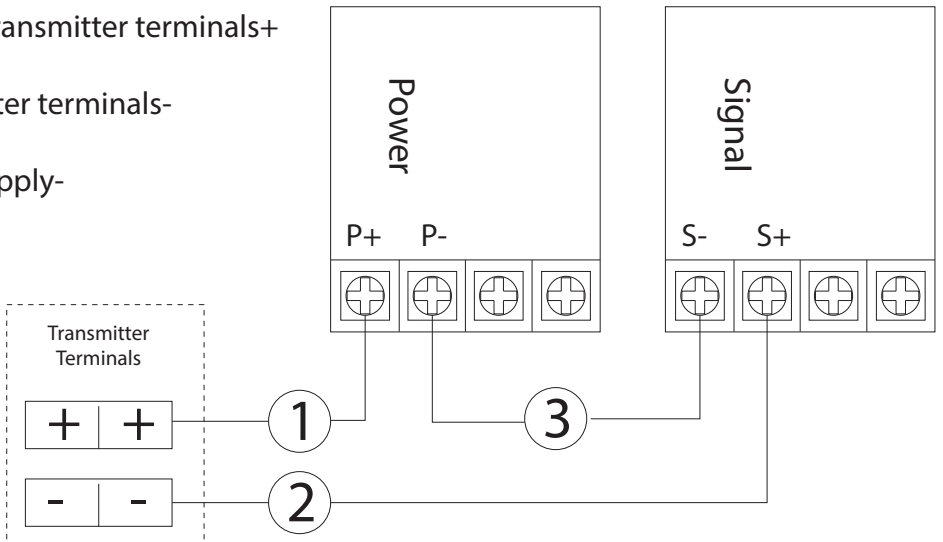

7. Grounding

- Shielded twisted pair signal cable is used to avoid ground loops.
- Shielded signal cable is used for signal grounding, insulated floating at the side of pressure transmitter, and grounding at the control cabinet.
- Internal ground terminals are used for direct grounding.

8. Configurations

The top nameplate (right side only) is located in the upper part of the transmitter. Slide the nameplate until the Zero/Span button is visible and fully accessible. External buttons operation is used in dangerous areas.



9. Installation of Transmitter

Liquid Flow Measurement

- Place the taps to the side of the line to prevent sediment deposits on the transmitters process isolators
- Mount the transmitter beside or below the taps so gases can vent into the process line
- Mount drain/vent the valve upward to allow gases to vent

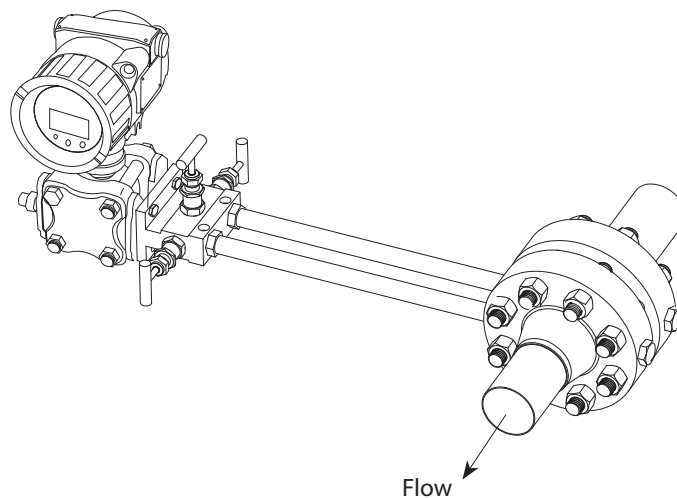

Quick Start Guide

Gas Flow Measurement

- Place taps in the top or side of the line
- Mount the transmitter beside or above the taps so liquid will drain into the process line

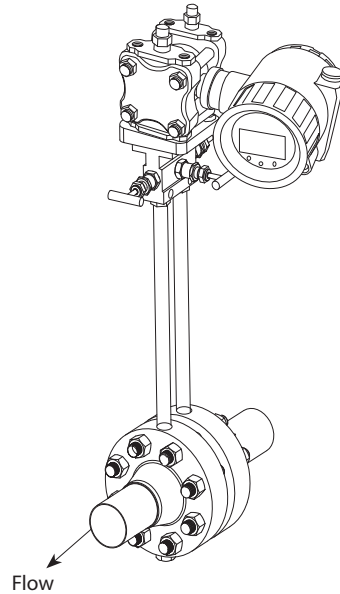

Steam Flow Measurement

- Place taps to the side of the line
- Mount the transmitter below the taps to ensure that the impulse piping will stay filled with condensate
- In steam service above 250 °F (121 °C), fill impulse lines with water to prevent the steam from contacting the transmitter directly and to ensure accurate measurement at start-up

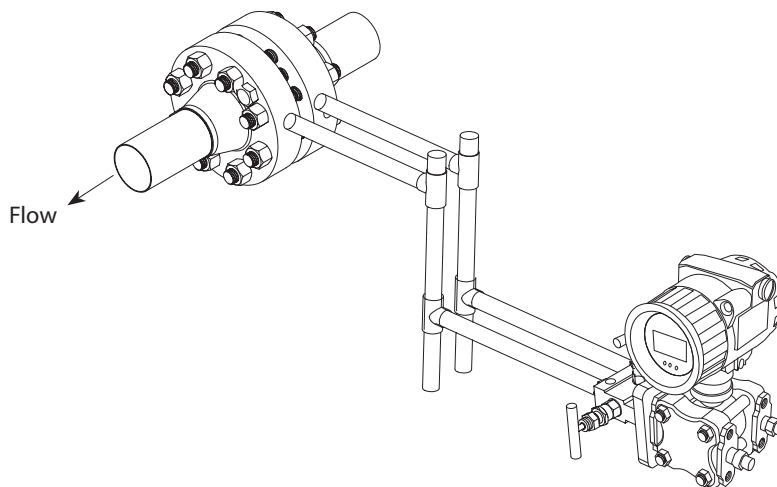

Note: For steam or other elevated temperature services, it is important that temperatures at the process connection do not exceed the transmitters process temperature limits.

10. Analog button programming menu

Keys operation

Set PV=0

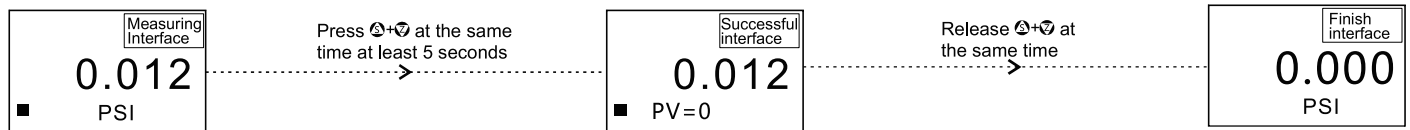

Factory reset

Method 1:

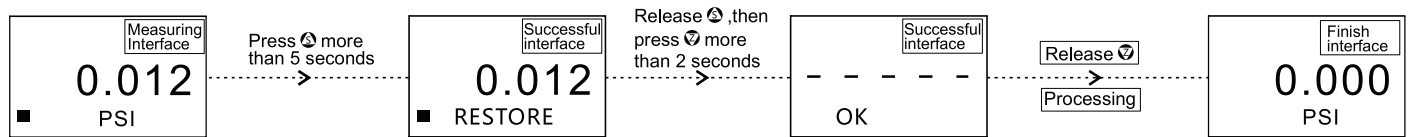

Method 2:

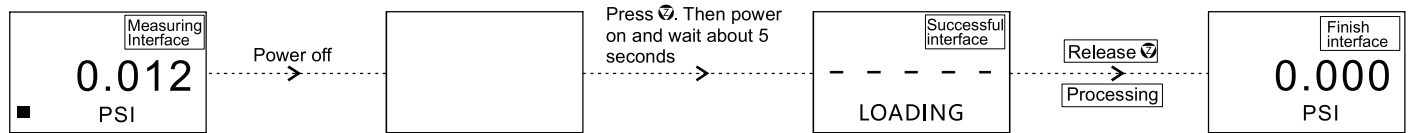

Sensor temperature display(SV: temperature & PV: pressure)dynamic switching, default temperature unit °F:

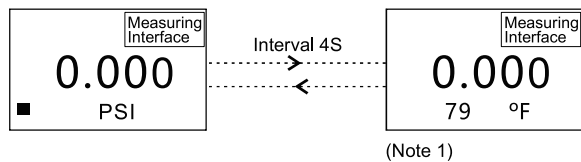

SV display mode:

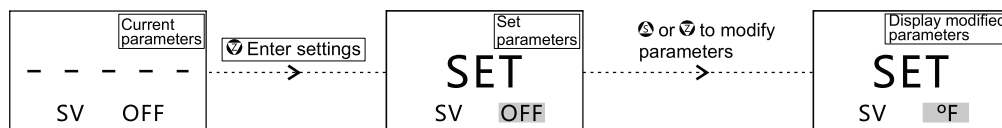

Quick Start Guide

Detailed operating instructions

Measuring Interface

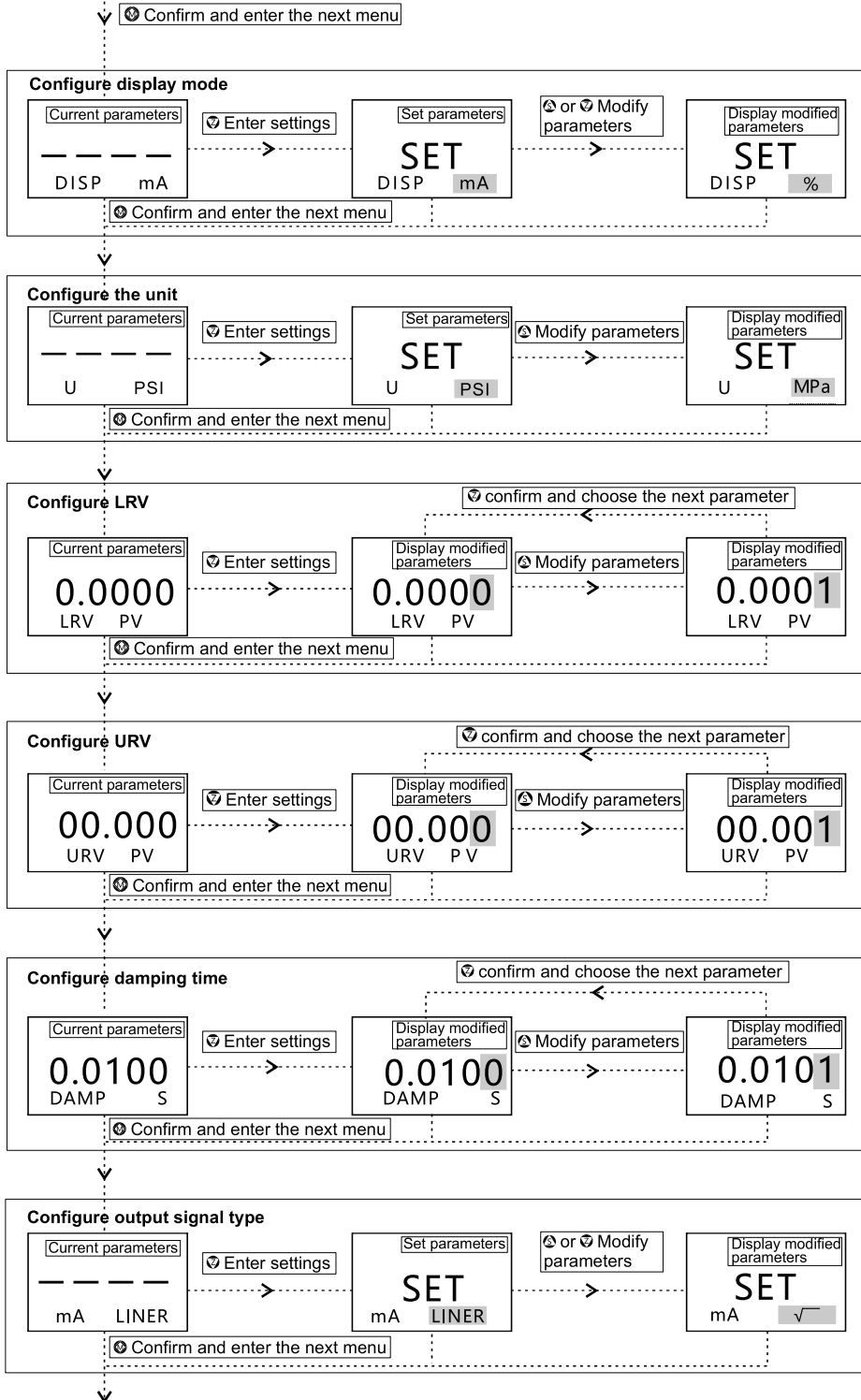
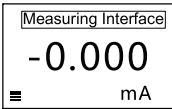

Parameters table

Display mode

%	Percentage
PV	Process variable
mA	Current

Square root display mode

%	<input type="checkbox"/>	%
PV	<input type="checkbox"/>	kPa
mA	<input type="checkbox"/>	mA

Units (\uparrow , \downarrow)

kPa
MPa
bar
psi
mmHg
mmH2O
mH2O
inH2O
ftH2O
inHg
mHg
TORR
mbar
g/cm2
kg/cm2
Pa
ATM
osi
mm
m

Lower range value

-19999-99999

Upper range value

-19999-99999

Damping time

0-100S

Output signal type

<input type="checkbox"/>	Square root
<input type="checkbox"/>	Linearity

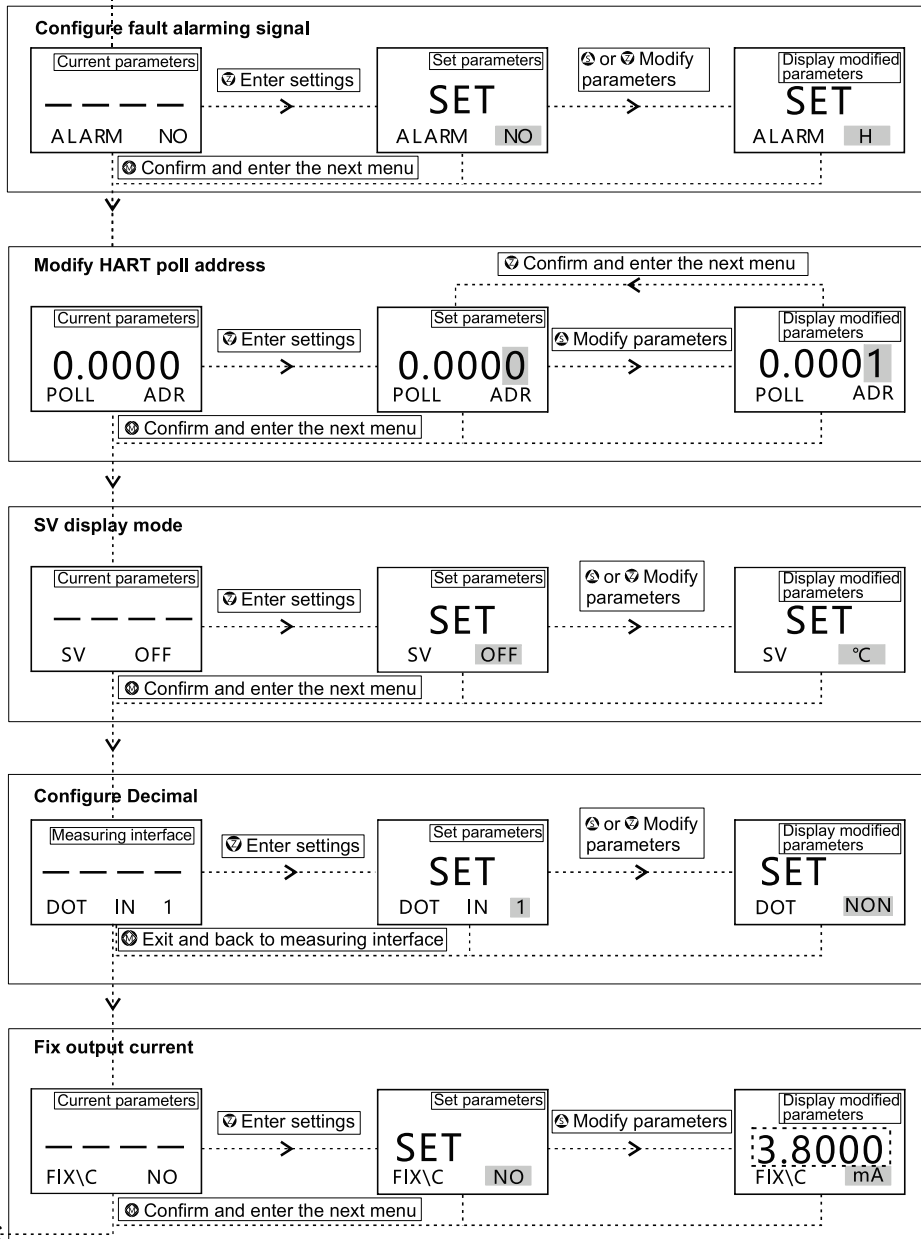

Fault alarm signal

No	Saturation output to 20.8mA or 3.8mA
H	20.8mA
L	3.8mA

Optional address 0-15

0: Broadcast address

1-15: Non-broadcast address

(fixed analog output to 4mA)

Display mode

OFF	None
°C	Celsius
°F	Fahrenheit
K	Kelvin

Dot options

NON	No decimals
1	Max one decimals
2	Max two decimals
3	Max three decimals

Loop current output

NO	Not fixed
3.8000	Fixed to 3.8mA
4.0000	Fixed to 4mA
8.0000	Fixed to 8mA
12.000	Fixed to 12mA
16.000	Fixed to 16mA
20.000	Fixed to 20mA
20.800	Fixed to 20.8mA

Quick Start Guide

11. Modbus Programming Menu

Keys operation

Set PV=0

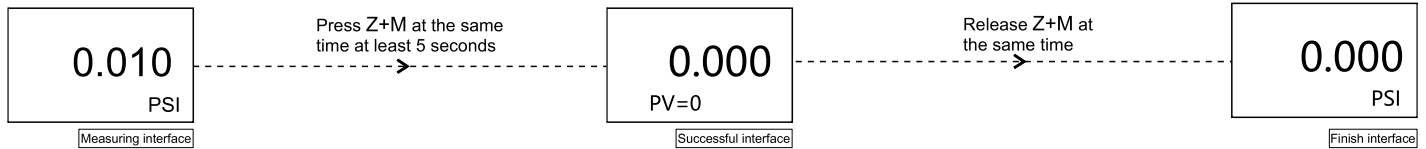

Full range adjustment

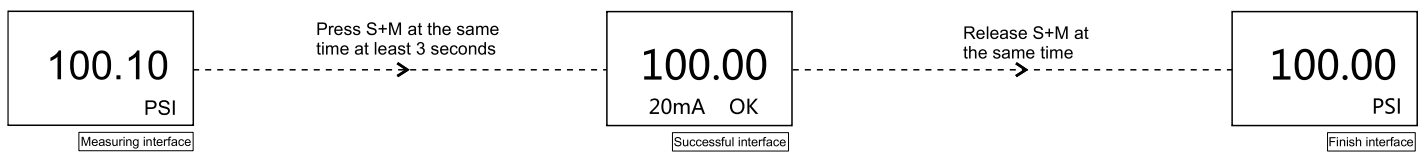

Factory reset

Method 1:

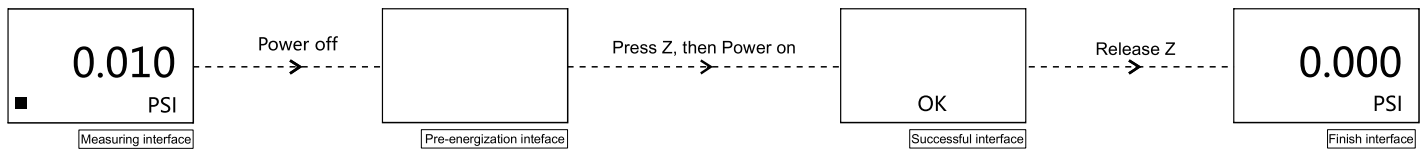

Method 2:

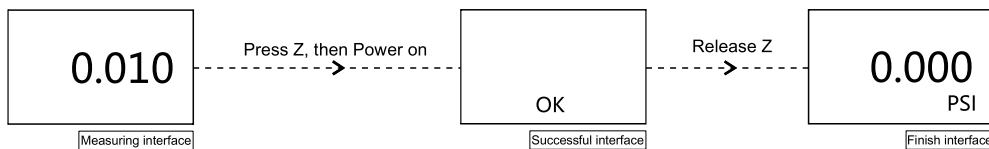

Temperature sensor unit switching:

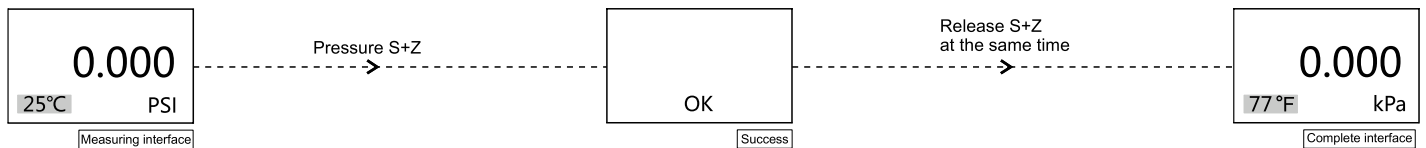

Detailed operating instructions

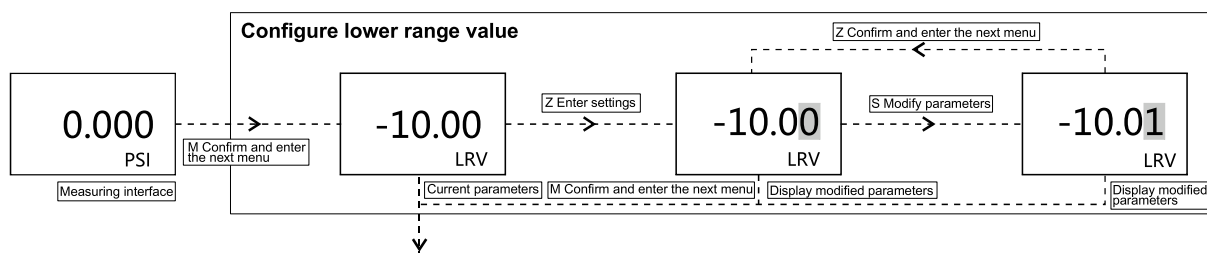

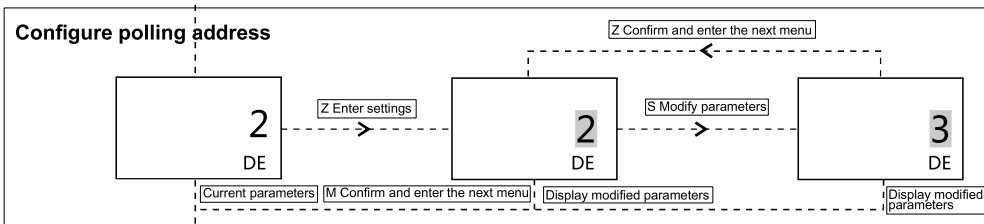
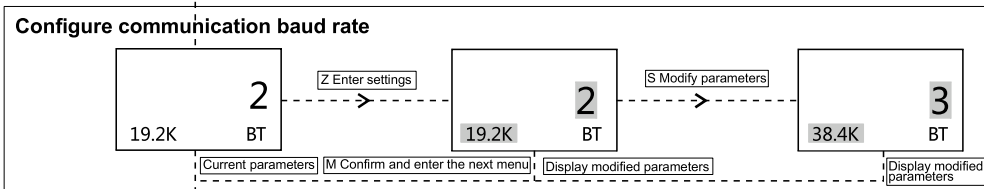
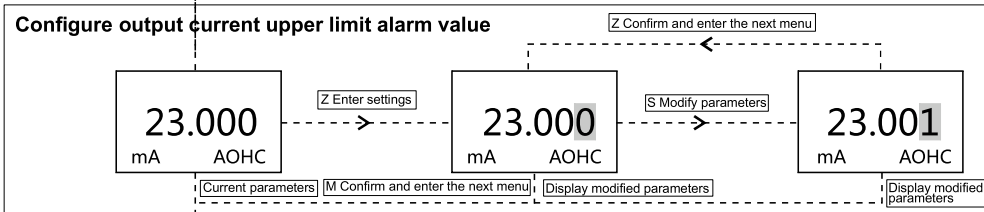
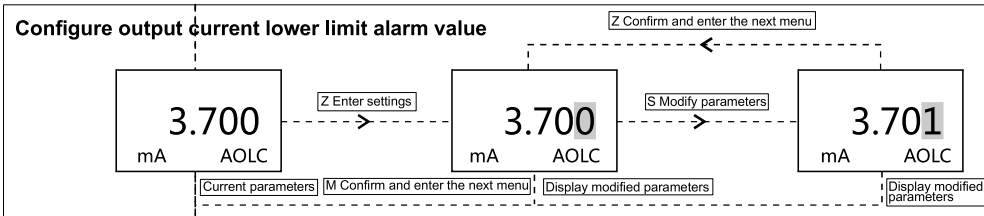
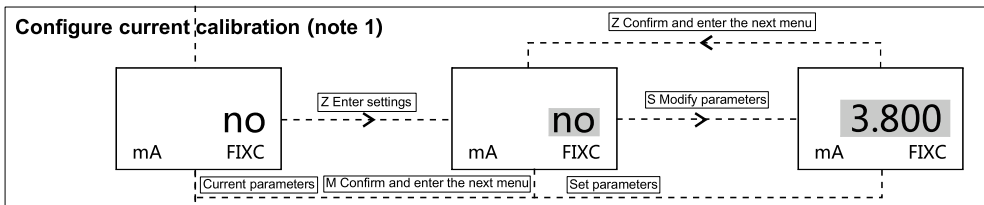
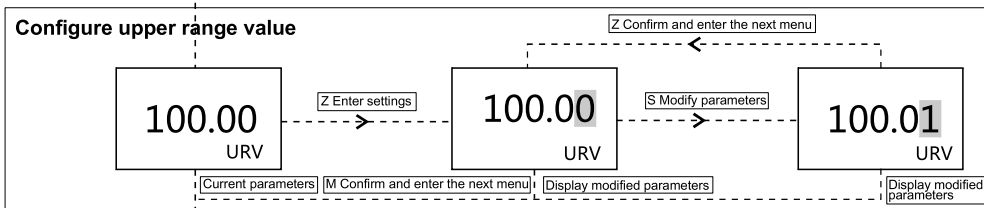

Lower range value

-19999-99999

Upper range value

-19999-99999

Calibration current

no (none)
3.800mA
4.000mA
8.000mA
12.000mA
16.000mA
20.000mA
23.000mA

Lower range alarm value

3.500-3.800mA

Upper range alarm value

20.800-24.000mA

Communication baud rate

0	4.8K
1	9.6K
2	19.2K
3	38.4K
4	57.6K
5	115.2K

Quick Start Guide

12. Menu Tree

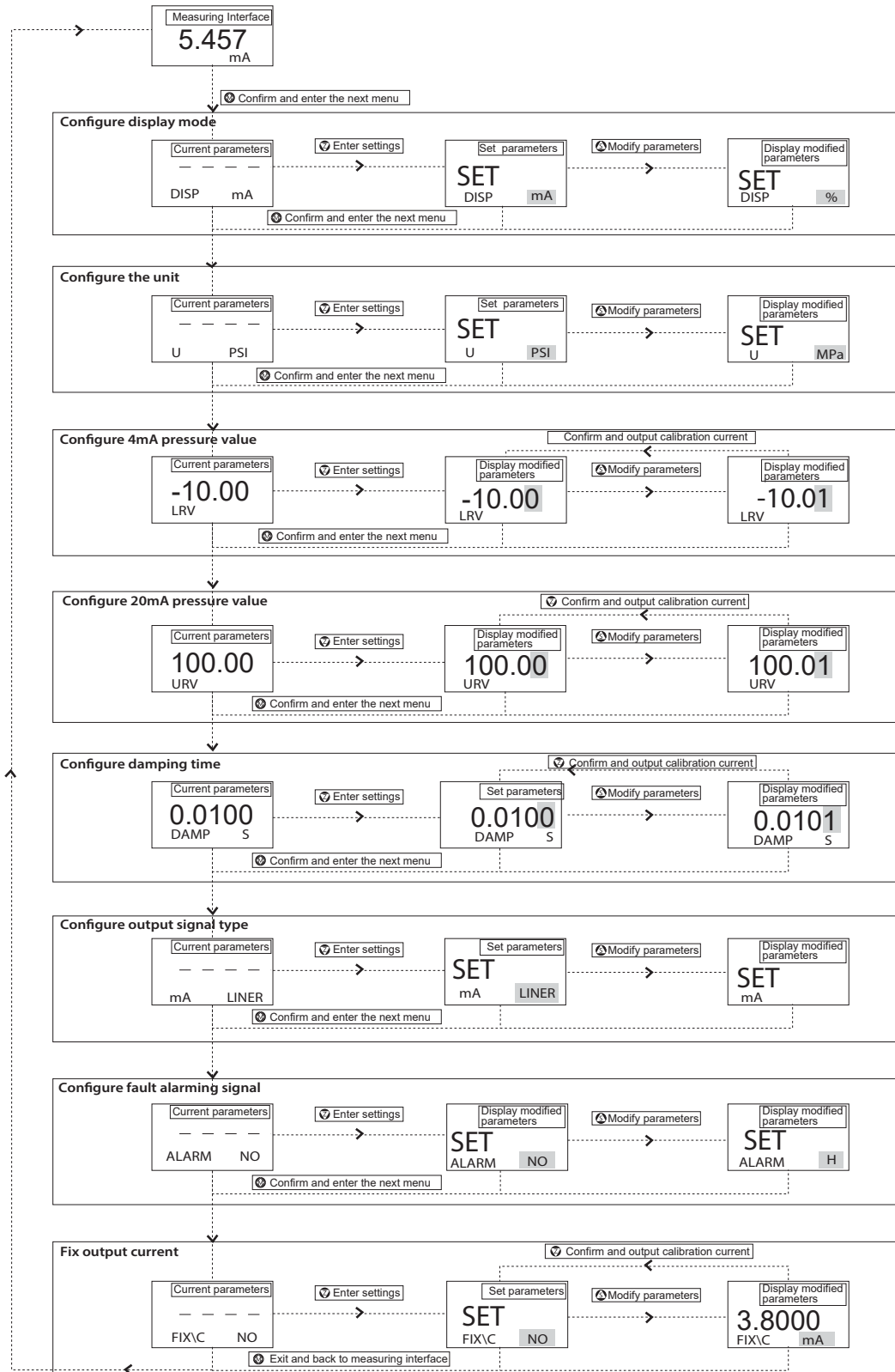

Parameters table

Display mode

%	Percentage
PV	Process variable
mA	Current

Units

(↕, ↕)

kPa
MPa
bar
psi
mmHg
mmH ₂ O
mH ₂ O
inH ₂ O
inHg
mHg
TORR
mbar
g/cm ²
kg/cm ²
Pa
ATM
mm
m

Lower range value

-19999-99999

Upper range value

-19999-99999

Damping time

0 to 100S

Output signal type

√	Square root
LINER	Linearity

Fault alarm signal

NO	None
H	20.8 mA
L	3.8 mA

Output current

NO (none)
3.8000 mA
4.0000 mA
8.0000 mA
12.000 mA
16.000 mA
20.000 mA
20.800 mA

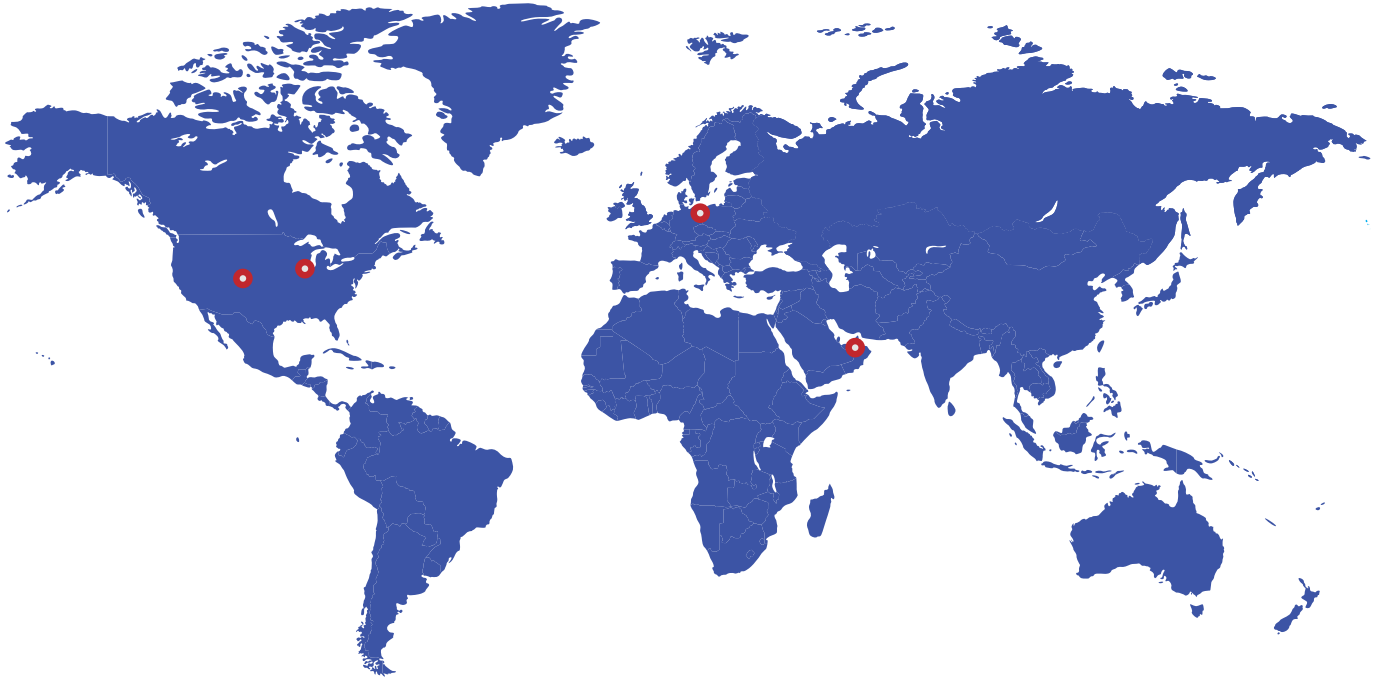

Tek-Trol LLC

796 Tek Drive Crystal Lake, IL
60014, USA
Sales: +1 847-857-6076

Tek-Dpro Flow Solutions

PO Box 121 Windsor, Colorado
80550, USA
Sales: +1 847-857-6076

Tek-Trol Solutions BV

Florijnstraat 18, 4879 AH
Etten-Leur, Netherlands
Sales: +31 76-2031908

Tek-Trol Middle East FZE

SAIF Zone, Y1-067, PO BOX No.
21125, Sharjah, UAE
Sales: +971-6526-8344

Support: +1 847-857-6076

Email: tektrol@tek-trol.com

www.tek-trol.com
