



Technology Solutions

TEK-CLAMP 1200A-100H ***Handheld Ultrasonic Flow Meter***

Instruction Manual

Document Number: IM-1200A-100H



www.tek-trol.com

NOTICE

Read this manual before working with the product. For personal and system safety, and for optimum product performance, make sure you thoroughly understand the contents before installing, using, or maintaining this product.

For technical assistance, contact

Customer Support

796 Tek-Drive

Crystal Lake, IL 60014

USA

Tel: +1 847 857 6076

© **COPYRIGHT Tek-Trol LLC 2022**

No part of this publication may be copied or distributed, transmitted, transcribed, stored in a retrieval system, or translated into any human or computer language, in any form or by any means, electronic, mechanical, manual, or otherwise, or disclosed to third parties without the express written permission. The information contained in this manual is subject to change without notice.

Table of Contents

1	Safety Instructions	3
1.1	Intended Use	3
1.2	Safety Instructions from the Manufacturer	3
1.2.1	Disclaimer	4
1.2.2	Product Liability and Warranty	4
1.2.3	Information Concerning the Documentation	4
1.2.4	Safety Precautions	4
1.2.5	Packaging, Transportation and Storage	5
1.2.5.1	Packaging The original package consists of	5
1.2.5.2	Delivery Contents	5
1.2.5.3	Optional Accessories	5
1.2.6	Transportation	6
2	Product Description	7
2.1	Introduction	7
2.2	Measuring Principle	7
2.3	Specifications	8
2.3.1	Technical Specifications for Hand-Held Device	8
2.3.2	Technical Specifications for Sensors	9
2.4	Dimensional Drawings	10
2.4.1	System Drawings	10
2.4.2	System Description	12
3	Installation	13
3.1	Correct Mounting Point	13
3.1.1	Clamp on Transducer:	13
3.1.2	Clamp on mounting bracket transducer	14
3.2	Requirements for Measuring Flow meter Accuracy	14
3.3	Installation Condition	15
3.3.1	Sensors	15
3.3.1.1	Selection Of Sensor Position	15
3.3.1.2	Sensor Installation	16
3.3.1.3	Spacing Between the Sensors	17
3.3.2	Selection of Measurement Method	17
3.3.2.1	V-method Installation:	17
3.3.2.2	Z-Method Installation	18
3.3.2.3	W-method Installation	19
4	Electrical Installations	20
4.1	Signal Strength	21
4.1.1	Signal Quality	21
4.2	Transmitter Connections	21
4.2.1	Basic Circuit of the Transmitter	21
4.3	Digital Output	21
4.3.1	The Connection of Digital Output	21
4.3.2	Key's Function	22
4.3.3	Menu	23

4.3.4	Keypad.....	23
4.3.5	Menu Windows.....	24
4.3.6	Menu Window List.....	25
4.3.7	Steps to Configure the Parameters.....	26
5	Menu Window Details.....	27
6	Troubleshooting.....	31
6.1	No Display.....	31
6.2	Exciting Alarm.....	31
6.3	Empty Pipe Alarm.....	31
6.4	Measure Flow Disallow.....	32
6.5	Error Messages After Switching On.....	32
6.6	Further Errors and Countermeasures.....	32
6.7	Further Errors and Countermeasures.....	33
7	Appendix.....	34
7.1	Tables: Pipe Size.....	34
7.1.1	Copper - Standard Pipe Size Charts:.....	34
7.1.2	PVC - Standard Pipe Size Charts:.....	35
7.1.3	Steel - Standard Pipe Size Charts:.....	36
7.1.4	Cast Iron Pipe - Standard Pipe Size Charts:.....	40
7.1.5	Ductile Iron Pipe - Standard Pipe Size Charts:.....	41
7.2	Tables: Sound Speed.....	42
7.2.1	Solids: Sound Speed Data.....	42
7.2.2	Water: Sound Speed.....	43
7.2.3	Liquids: Sound Speed.....	44
8	Parts Descriptions.....	50

1 Safety Instructions

Please read this manual carefully and completely before you use the device for the first time. The device may only be used by qualified personnel and repaired by Tek-Trol LLC personnel. Damage or injuries caused by non-observance of the manual are excluded from our liability and not covered by our warranty.

1.1 Intended Use

Tek-Clamp 1200A-100H is a Handheld Ultrasonic Flow Meter are used only for measure the flow of liquids in closed pipes, e.g.: clean water, wastewater etc.

The manufacturer is not liable for damage caused by improper or non-designated use.

1.2 Safety Instructions from the Manufacturer

This meter was calibrated at the factory before shipment. To ensure correct use of the meter, please read this manual thoroughly.

- The device must only be used within the approved temperature range:
 - a) Environmental humidity max. <80 % RH
 - b) Environmental temperature 0 ... +70 °C
- Do not expose the device to extreme temperatures, direct sunlight, extreme humidity, condensation, or moisture.
- With wet hands never use the instrument.
- Before taking a measurement, the device should be stabilised to the ambient temperature (important when carrying the device from cold to warm rooms and vice versa).
- Avoid strong electrical shocks.
- Do not use the meter around corrosive or explosive gases.
- The case should only be opened by qualified Tek-Trol LLC personnel.
- Repairs and maintenance work may only be carried out by qualified Tek-Trol LLC personnel.
- Never place the front side of the device on a workbench or work surface to avoid damage to the operating elements.
- You must not make any technical changes to the device.
- Keep the flow meter clean and dry.
- The appliance should only be cleaned with a damp cloth. Use only pH-neutral cleaner, no abrasives, or solvents.
- Non-observance of the safety notes can cause damage to the device and injuries to the user.

We do not assume liability for printing errors or any other mistakes in this manual. We expressly point to our general guaranteed terms which can be found in our general terms of business. If you have any questions, please contact Tek-Trol LLC. The contact details can be found at the end of this manual.

1.2.1 Disclaimer

The manufacturer will not be held accountable for any damage that happens by using its product, including, but not limited to direct, indirect, or incidental and consequential damages. Any product purchased from the manufacturer is warranted in accordance with the relevant product documentation and our Terms and Conditions of Sale.

The manufacturer has the right to modify the content of this document, including the disclaimer, at any time for any reason without prior notice, and will not be answerable in any way for the possible consequence of such changes.

1.2.2 Product Liability and Warranty

The operator shall bear authority for the suitability of the device for the specific application. The manufacturer accepts no liability for the consequences of misuse by the operator. Wrong installation or operation of the devices (systems) will cause the warranty to be void. The respective Terms and Conditions of Sale, which forms the basis for the sales contract shall also apply.

1.2.3 Information Concerning the Documentation

To prevent any injury to the operator or damage to the device it is essential to read the information in this document and the applicable national standard safety instructions. This operating manual contain all the information that is required in various stages, such as product identification, incoming acceptance and storage, mounting, connection, operation and commissioning, troubleshooting, maintenance, and disposal.

1.2.4 Safety Precautions

You must read these instructions carefully prior to installing and commissioning the device. These instructions are an important part of the product and must be kept for future reference. Only by observing these instructions, optimum protection of both personnel and the environment, as well as safe and fault-free operation of the device can be ensured.

Warnings and Symbols Used

The following safety symbol marks are used in this operation manual and on the instrument.



WARNING

Indicates a potentially hazardous situation which, if not avoided, could result in death or serious injury.



CAUTION

Indicates a potentially hazardous situation which, if not avoided, may result in minor or moderate injury. It may also be used to alert against unsafe practices.



NOTE

Indicates that operating the hardware or software in this manner may damage it or lead to system failure.

1.2.5 Packaging, Transportation and Storage

1.2.5.1 *Packaging* The original package consists of

1. Tek-Clamp 1200A-100H Handheld Ultrasonic Flow Meter
2. Documentation

1.2.5.2 *Delivery Contents*

- 1 x Ultrasonic Flow Meter
- 2 x Sensor (depending on model)
- 2 x 5 m connection cable
- 2 x Releasable cable tie
- 1 x Mains adaptor
- 1 x Contact gel
- 1 x Tek-Trol measuring tape
- 1 x Carrying case
- 1 x User manual

1.2.5.3 *Optional Accessories*

S1	Sensor type S1 (loose)
M1	Sensor type M1 (loose)
HS	Sensor type HS (on rail)
HM	Sensor type HM (on rail)
TT-GEL	Ultrasonic contact gel
Sensor Cable Tek-Clamp 1200A Series	Set of sensor cables 2 x 5 m
CAL- Tek-Clamp 1200A Series ISO	ISO calibration certificate



NOTE

Unpack and check the contents for damages or signs of rough handling. Report damage to the manufacturer immediately. Check the contents against the packing list provided.



1.2.6 Transportation

- Avoid impact shocks to the device and prevent it from getting wet during transportation.
- Verify local safety regulations, directives, and company procedures with respect to hoisting, rigging, and transportation of heavy equipment.
- Transport the product to the installation site using the original manufacturer's packing whenever possible. 1.4.3 Storage the Tek-Clamp 1200A-100H is designed for installation and usage purpose in typical commercial/industrial environments. The following considerations must be observed in selecting a location for the meter:
 - The ambient operating temperature range is -22°F (-30°C) to 176°F (80°C).
 - Do not expose the meter to corrosive liquids or fumes.
 - Avoid installation locations that are close to strong sources of electrical interference.
 - Avoid installing the electronics enclosure in direct sunlight.
 - Avoid installation locations where the transducers will be exposed to vibrations in the piping system.
 - Always run transducer cables in a dedicated conduit separate from signal and power cables.
 - Allow sufficient space for daily inspection, wiring, etc.
 - Avoid installing the meter at a place subjected to, or at risk of, flooding.

2 Product Description

This section covers the reference and specification data, as well as ordering information.

2.1 Introduction

Tek-Clamp 1200A-100H Handheld Ultrasonic Flow Meter is a completely non-invasive Ultrasonic Flow Meter. The flow meter uses the ultrasonic signal to measure the flow rates with the transit time method. It consists of the built-in data logger for over 2000 lines of data and is optional as an external data logger. Tek-Clamp 1200A-100H has a pair of transducers capable of measuring flow rates in pipes from 1/2" (12.5 mm) to 28" (700 mm) at temperatures of between 32 °F (0 °C) to 320 °F (160 °C). This flow meter can be virtually applied to a wide range of measurements. A variety of liquid applications contain potable water, cooling water, river water, raw sewage, reclaimed water, plant effluent, ultra-pure liquids, chemicals.

2.2 Measuring Principle

When the ultrasonic wave is transmitted through the flowing liquid, the difference between the upstream and downstream transit time (travel time or time of flight) can be calculated, which is proportional to flow velocity.

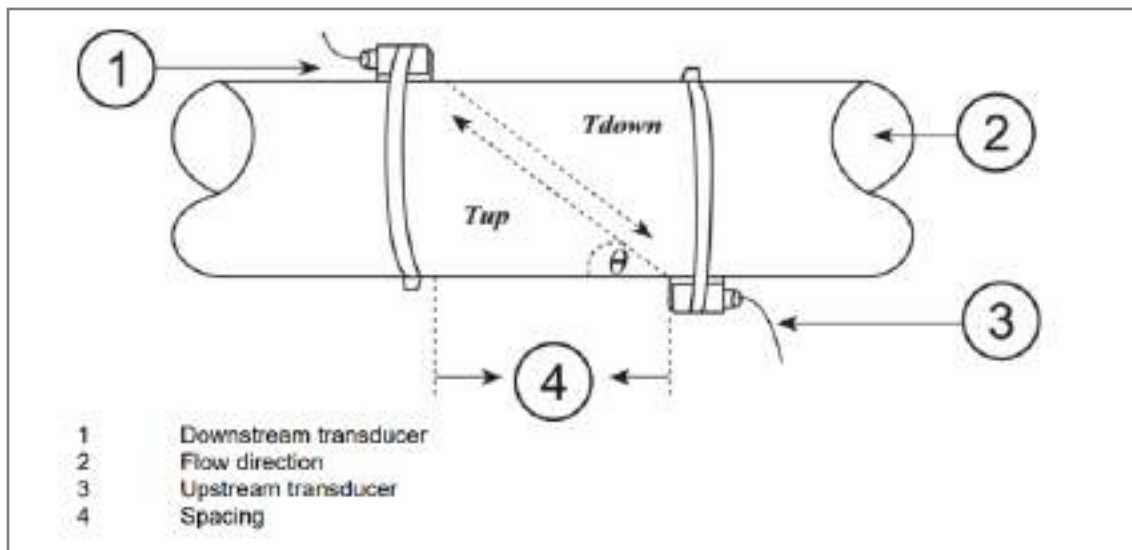

Fig 1: Tek-Clamp 1200A-100H Handheld Ultrasonic Flow Meter

The Tek-Clamp 1200A-100H has been developed to measure the flow velocity of liquids in pipes. The non-contact transducers/sensors are placed on the pipes and thus not subject to wear and tear. The Tek-Clamp 1200A-100H works with two signal transducers (sensors) that serve as ultrasonic transmitters and ultrasonic receivers. The sensors are installed on the outer wall of the pipe at a defined distance, one below the other. The sensors can be installed in Z shape (Z method). In this case, the ultrasound will pass through the pipe once. The ultrasound will pass through the pipe four times if the sensors are installed in W shape (W method). When using the Z method, the sensors are placed opposite to each other.

The sound passes through the pipe or liquid diagonally. The selection of the right method depends on the characteristics of the liquid.

The formula for calculating velocity is:

$$V = \frac{MD}{\sin 2\theta} \times \frac{\Delta T}{T_{up} \times T_{down}}$$

Where,

- θ: Includes angle to the flow direction
- M: Travel times of the ultrasonic beam
- D: Pipe diameter
- T_{up} : Time for the beam from upstream transducer to the downstream one
- T_{down} : Time for the beam from downstream transducer to the upstream one
- ΔT=T_{up}- T_{down}

2.3 Specifications

2.3.1 Technical Specifications for Hand-Held Device

Accuracy	±1% of reading at rates >0.2 mps	
Velocity Range	0.03 to 100ft/sec	
Repeatability	0.2%	
Resolution	0.0003 ft/s	
Measurement Period	0-999 seconds, user-configurable	
Measurement Principle	Transit Time Ultrasonic Flow Meter	
Media	All liquids with solids of <5 % and a flow of >0.19pm	
Flow Units	Cubic meter	m ³
	Liter	l
	Gallon	gal
	Imperial Gallon (UK)	igal
	Million USA Gallons	mgal
	Cubic foot	cf
	Barrel (USA)	bal
	Imperial Barrel (UK)	ib
	Oil Barrel	ob
	The time can be per day [/d], per hour [/h], per minute [/m] and per second [/s]	
Weight	Portable transmitter weight 514g Package with accessories weight 6kg Volume weight for whole package 12kg	
Power	100H	3 AAA built-in Ni-MH batteries 1.2V (for over 12 hours of operation) 90V-260V AC adapter

Power Consumption	1.5W
Environment Temperature	Convertor: -4°F to 140 °F (-20 to 60°C) Flow Transducer: -22°F to 320°F (-30 to 160°C)
Environment Humidity	Convertor: 85% RH
Protection Class	Flow Transducer: IP67
Clamp-On	HS-type: for pipe size ½"- 4" (12.5mm -100 mm) HM-type: for pipe size 2"- 28" (50mm- 700 mm) Other pipe size available on request
Types	Following Liquids transmit sound wave: <ul style="list-style-type: none"> • Single liquid such as, Water (Hot water, Chilled water, City Water, Sea Water, Wastewater, etc.) • Sewage with small particle content • Oil (crude oil, lubricating oil, diesel oil, fuel oil, etc.) • Chemicals (alcohol, etc.) • Plant Effluent • Beverage • Ultra-pure liquids
Process Temperature	-22°F to 320°F (-30°C to 160°C)
Pipe Material	Steel, Stainless Steel, Cast Iron, Copper, Cement Pipe, PVC, Aluminum, Glass Steel Product, Liner is allowed
Pipe Size	1/2" to 28"
Pipe Straight Run	Transducer installation should be satisfied: upstream10D, downstream 5D, 30D from the pump
Dimensions	8"X 3¾" X 1¼" (200 X 93 X 32mm) (Convertor)

2.3.2 Technical Specifications for Sensors





Types Of Sensors	S1	M1	HS	HM
Image				
Order No. Sensor	S1 (Optional)	M1(Optional)	HS	HM
Order no. hand-held device + sensor	Tek-Clamp 1200A-100H	Tek-Clamp 1200A-100H	-----	-----
Sensor cable length	5m	5m	5m	5m
Nominal diameter	DN 15 ... DN 100 0.787"	DN 50 ... DN 700 2.24" ... 28.34"	DN 15 ... DN 100 20 ... 4.25"	DN 50 ... DN 700 57 ... 28.34"
Liquid temperature	-86°F to 320°F	-86°F to 320°F	-86°F to 320°F	-86°F to 320°F
Dimensions	1.77"x1.18"x1.18"	2.36"x1.77"x1.77"	7.87" x0.98"x0.98"	11.02"x1.57"x1.57"
Weight	75 g	260 g	250 g	1080 g

Fig 3: Front View of 1200A-100H Handheld Ultrasonic Flow Meter

2.4 Dimensional Drawings

2.4.1 System Drawings

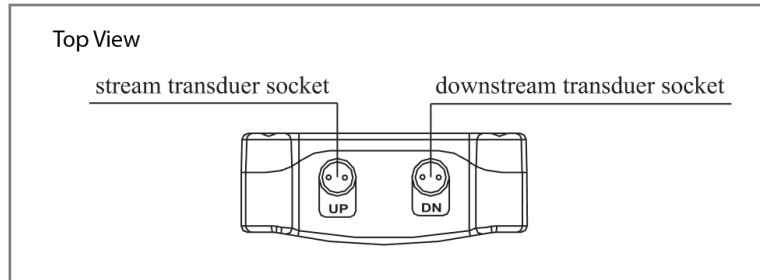

Fig 2: Top View of 1200A-100H Handheld Ultrasonic Flow Meter

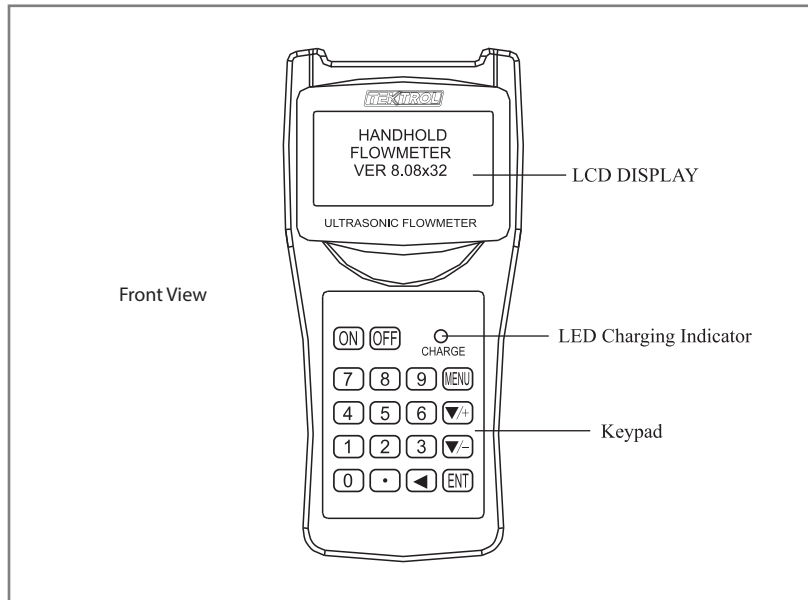

Fig 3: Front View of 1200A-100H Handheld Ultrasonic Flow Meter

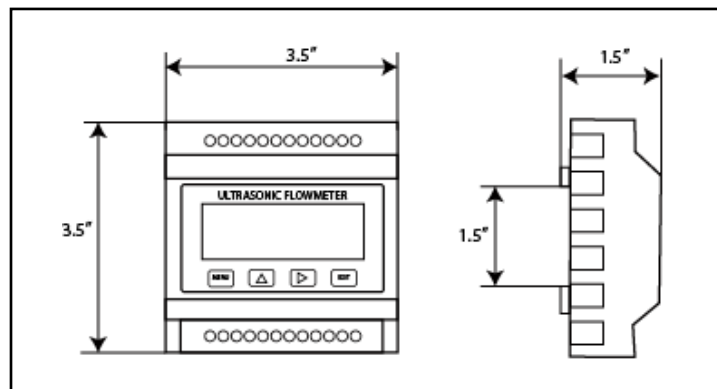

Fig 4: Dimension Drawing of 1200A-100H Handheld Ultrasonic Flow Meter

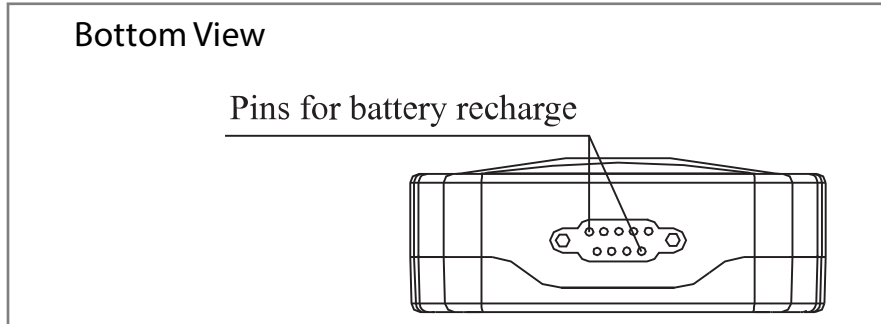

Fig 5: Bottom View of 1200A-100H Handheld Ultrasonic Flow Meter

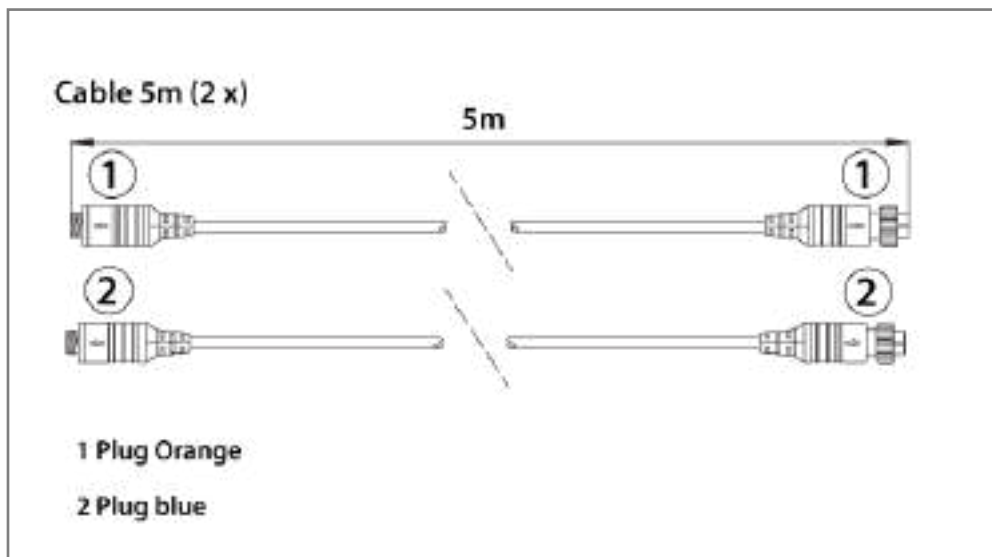

Fig 6: Cables of 1200A-100H Handheld Ultrasonic Flow Meter

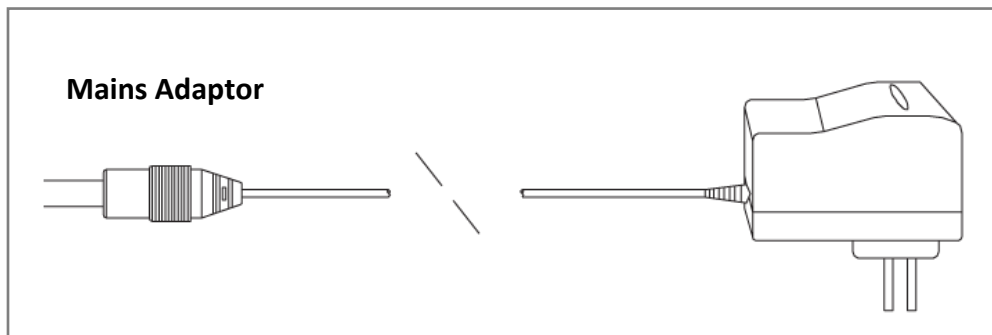

Fig7: Mains Adaptor of 1200A-100H Handheld Ultrasonic Flow Meter

2.4.2 System Description



Fig 8: System Description

3 Installation

This section covers instructions on installation and commissioning. Installation of the device must be carried out by trained; qualified specialists authorized to perform such works.



CAUTION

- When removing the instrument from hazardous processes, avoid direct contact with the fluid and the meter
- All installation must comply with local installation requirements and local electrical code

3.1 Correct Mounting Point

The correct mounting point is a major factor for the installation of a flow Meter. Installation at wrong point may influence measuring accuracy or flow meter service life, or even damage the flow meter.

The axis for measuring electrode shall be approximate to horizontal direction.

Tek-Clamp 1200A-100H Handheld Ultrasonic Flow Meter can simplify the ultrasonic flow meter installation process, by shortening installation time and improving installation accuracy. Tek-Clamp 1200A-100H Handheld Ultrasonic Flow Meter installed by two methods:



Fig 9: Tek-Clamp 1200A-100H Handheld Ultrasonic Flow Meter

3.1.1 Clamp on Transducer:

Install the Tek-Clamp 1200A - 100H Handheld Ultrasonic Flow Meter (with magnet) on the pipe. It can help finish the flow measurement without any pressure drop. The need for cutting the pipe is eliminated.

3.1.2 Clamp on mounting bracket transducer

- Install Tek-Clamp 1200A - 100H on the pipe, to finish the flow measurement. The need for cutting pipe gets eliminated.
- Several types of bracket Tek-Clamp 1200A - 100H are used to measure pipe size from 1/2" to 28".
- Several types of bracket Tek-Clamp 1200A - 100H are used to measure temperature range from -22°F to 320°F (-30°C to 160°C)

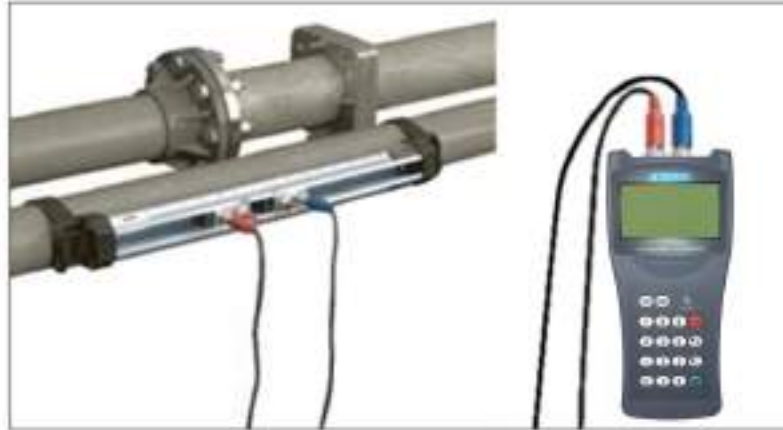

Fig 10: Tek-Clamp 1200A-100H Handheld Ultrasonic Clamp-on mounting bracket transducer

3.2 Requirements for Measuring Flow meter Accuracy

- The pipe should be completely filled with the medium.
- There must be a straight pipe run no less than 5DN at flow meter upstream and 2DN at flow meter downstream. (DN is the internal diameter of the pipeline).
- Do not install the flow meter near large electrical machine or transformer in order to avoid the electromagnetic interference.



NOTE

Do not expose the electronic unit box to direct sunlight; in case of outdoor installation, use a suitable protection shield.

3.3 Installation Condition





3.3.1 Sensors

3.3.1.1 Selection Of Sensor Position

The first step before installation should be finding a suitable position to place the sensors. This is a requirement for accurate measurement results. Some basic knowledge about the pipes / the plumbing system is necessary.

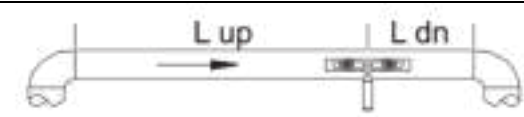
The ideal location would be an infinitely long, straight pipe, whereas there must be no entrapped air (air bubbles) in the liquid. The pipes can either run vertically or horizontally. A straight flow-calming section before and behind the measuring point should be considered to avoid inaccuracies due to turbulence in the liquid. In general, the section in front of the measuring point should be at least 10 x the pipe diameter, and after the measuring point, it should be 5 x the pipe diameter.

The following chart shows examples of good positions:

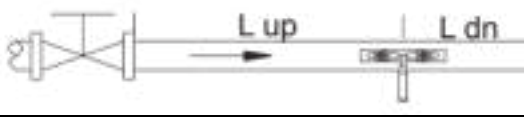
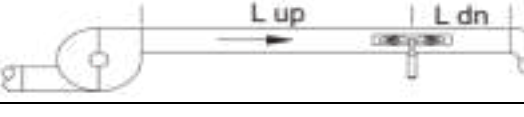
Pipe routings and sensor position	Upstream	Downstream
	$L_{up} \times \phi$	$L_{dn} \times \phi$
	10D	5D
	10D	5D
	10D	5D
	12D	5D
	20D	5D
	20D	5D
	30D	5D

The following should be considered when looking for a good measuring position:

1. Install the sensors on a preferably long, straight pipe filled with the liquid and does not contain any air bubbles.
2. Make sure that the liquid and thus the pipe is not too hot for the sensors. The temperature should be as similar to the room temperature as possible.
3. Consider fouling of the pipes. If possible, choose a clean or new pipe for measurement. You can also clean the pipe. If this is not possible, consider the thickness of the fouling as part of the liner.
4. Some pipes have a synthetic liner. There can be a boundary layer between the outer pipe and the liner. This boundary layer can divert or weaken the ultrasonic waves, which will make a measurement very difficult. If possible, these types of pipes should be avoided. If this is not possible, sensors can also be built into the pipe

3.3.1.2 *Sensor Installation*

The Tek-Clamp 1200A-100H has piezoelectric sensors which can transmit and receive ultrasonic waves. The ultrasonic waves pass through the pipe walls, and the liquid allows conclusions about the flow velocity. As the transit time of the ultrasonic pulses is very short, the sensors should be installed as precisely as possible to ensure the highest system accuracy.

Take the following steps to install the sensors:

- Some pipes have a plastic liner. There can be a boundary layer between the outer diameter of the pipe and the inner liner. This boundary layer can divert or weaken the ultrasonic waves. In this case, an accurate measurement will be very difficult. If possible, these types of pipes should be avoided.
- Find an ideal position in the piping system, i.e., a straight section with new and clean pipes, if possible.
- The pipes must be clean. Grind or polish the locations where you would like to place the sensors.
- If pollution cannot be removed, its thickness should be considered part of the pipe's liner.
- There must not be an air gap between the sensors and the surface of the pipe. Attach the sensors using sufficient contact gel.
- Moreover, you should make sure there is no dust or sand between the pipe and the sensor. To avoid air bubbles from causing measurement errors, place the sensors on the pipe laterally.

3.3.1.3 Spacing Between the Sensors

The distance between the upstream and the downstream sensor can be seen in window M25. The window states the inner distance between the two sensors, which you should stick to as accurately as possible. The information in M25, however, must only be considered a coarse adjustment. The fine adjustment is carried out by arranging the spacing so that the time constant in M90 is exactly 100%.

To ensure accurate measurement values, the following data must be entered:

- The outer diameter of the pipe (M11)
- Material thickness of the pipe (M12)
- Material of the pipe (M14)
- The liner of the pipe (M16)
- Type of liquid (M20)
- Type of sensors connected (M23)
- The mounting method of sensors (M24)
- Check the spacing in window M25 and fix the sensors accordingly.
- During installation, ensure that the value of the time constant in M90 is 100 %, that the signal strength is >700 and that the signal quality is >60.

3.3.2 Selection of Measurement Method

3.3.2.1 V-method Installation:

V-method installation is the most widely mode for daily measurement with pipe inner diameters ranging from 15 mm to 400 mm (½" to 16"). It is also called reflective mode.

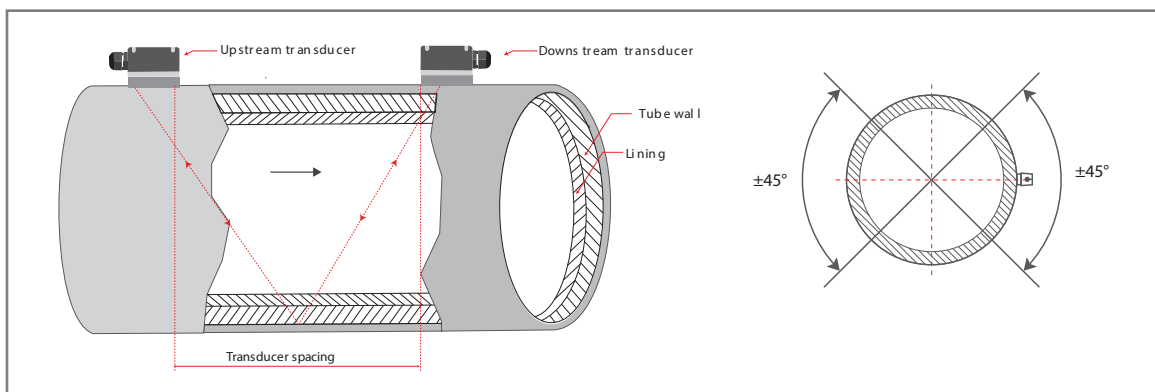

Fig 11: V-method Installation

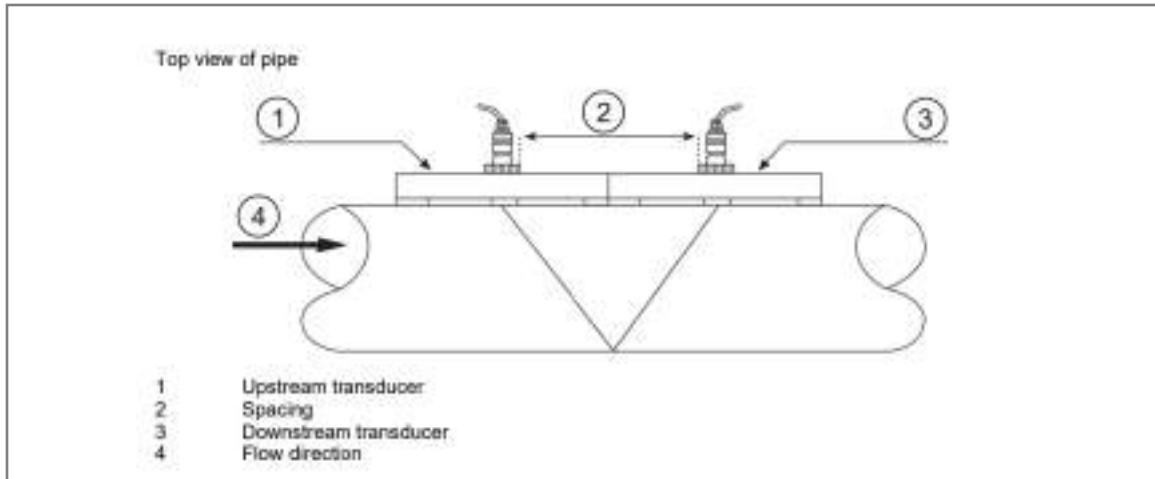

Fig 12: V-Method Installation Top View

3.3.2.2 Z-Method Installation

Z-method is commonly used when the pipe diameter is above 8" (200mm).

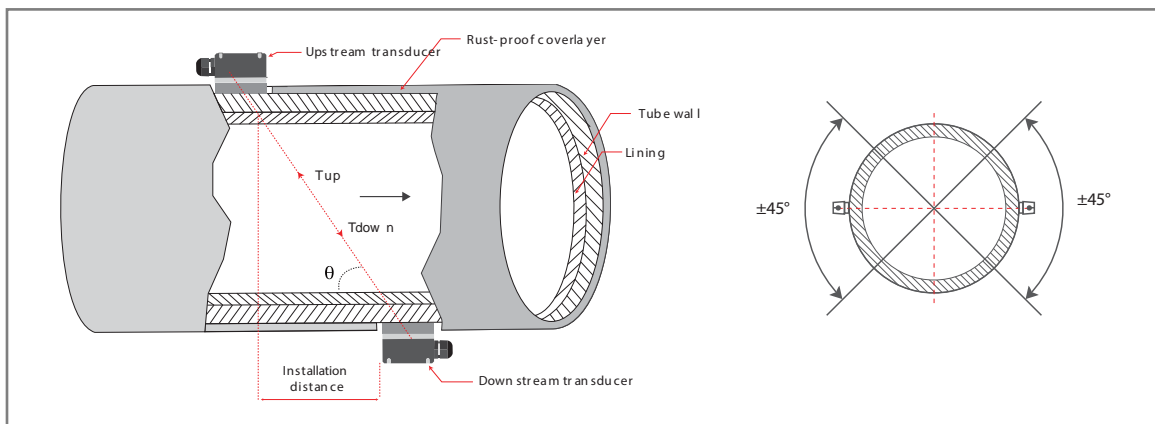

Fig 13: Z-Method Installation

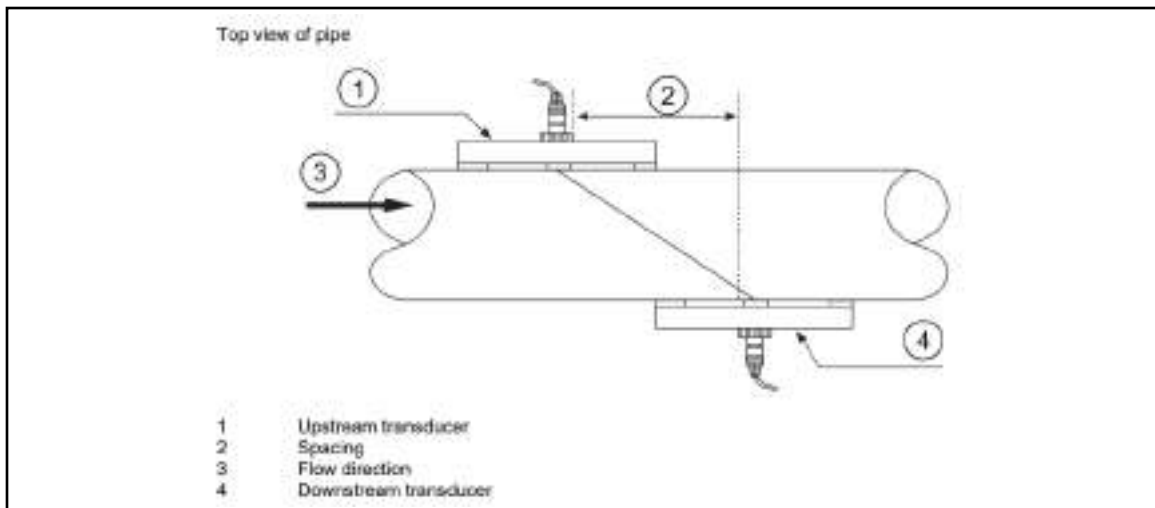

Fig 14: Z-Method Installation Top View

3.3.2.3 W-method Installation

W-method is usually used on plastic pipes with a diameter from 2" (15mm to 50mm).

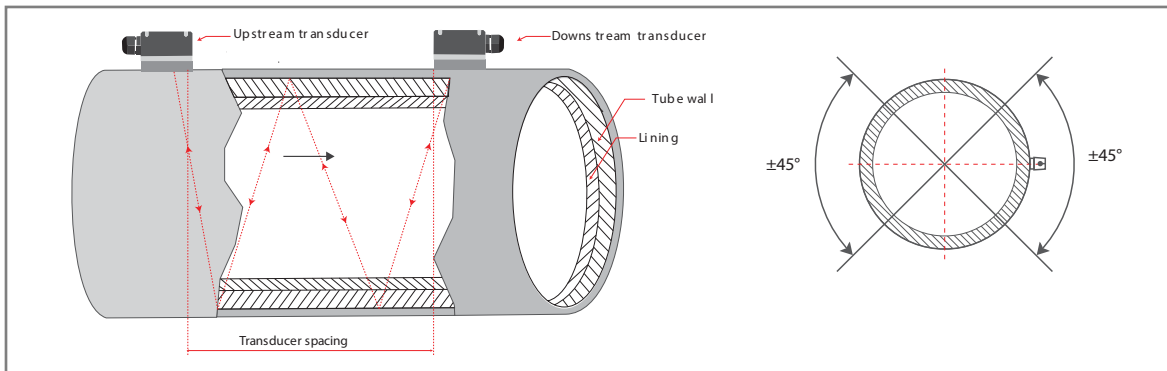

Fig 15: W-Method Installation

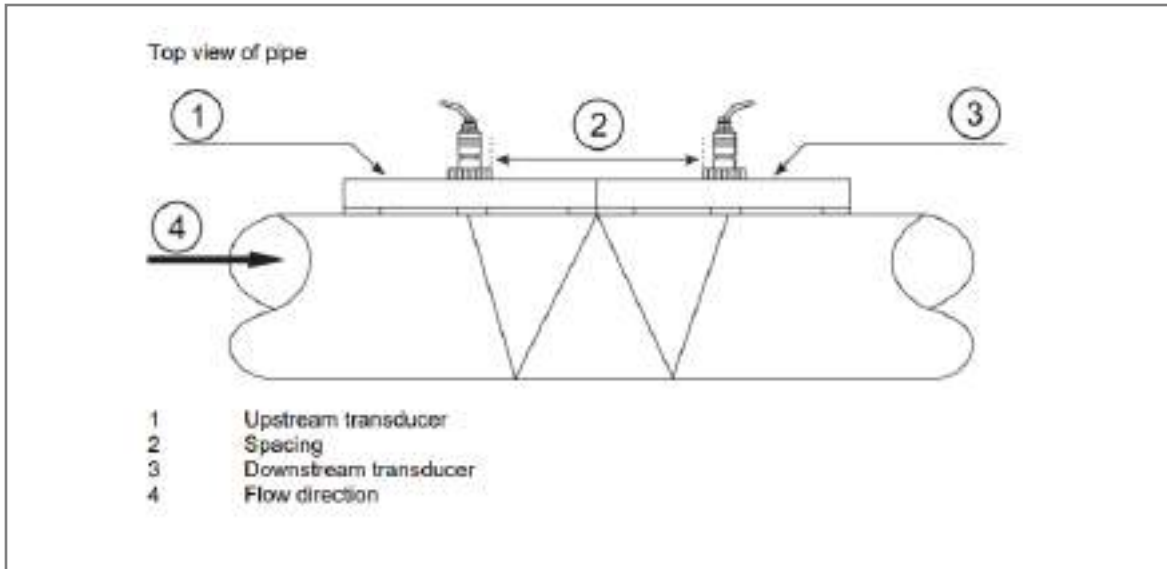

Fig 16: W-Method Installation Top View

4 Electrical Installations

- Please cut off power supply before connecting the device
- Check the cable model before connecting the cable.
- Follow the procedure for cable into lead collar: -
- At first, loosen the gland nut on lead collar and take off blind, secondly, put gland nut and rubber ring on cable, make the cable through lead collar; finally, straighten out cable, screw gland nut tight to make rubber ring press cable.
- When wire stripping, do not damage insulating layer which should be reserved.

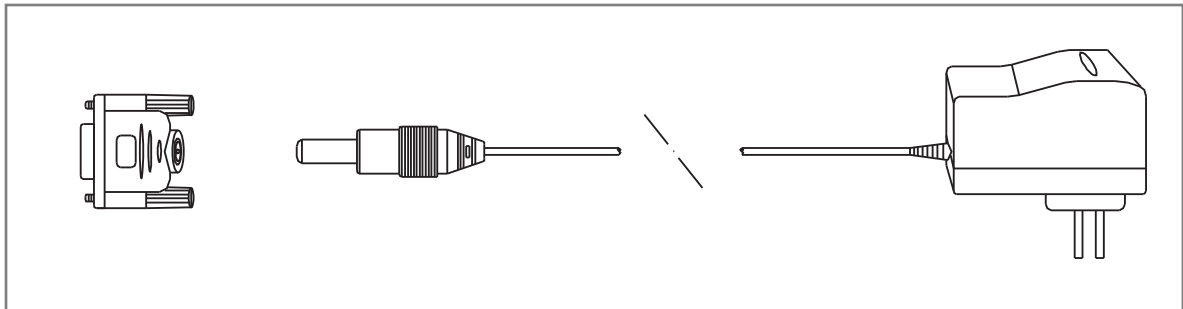

Fig 17: TEK-Clamp 1200A-100H Electrical Connections Cables.

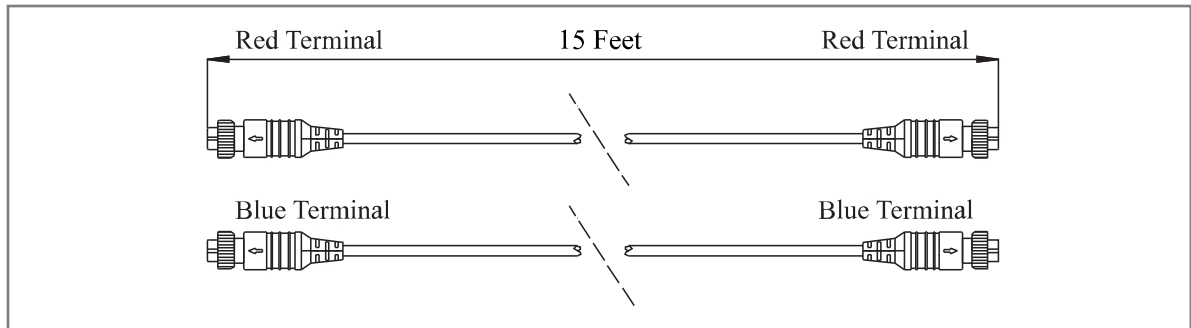

Fig 18: Tek-Clamp 1200A-100H Converted Terminal And AC/DC Adaptor

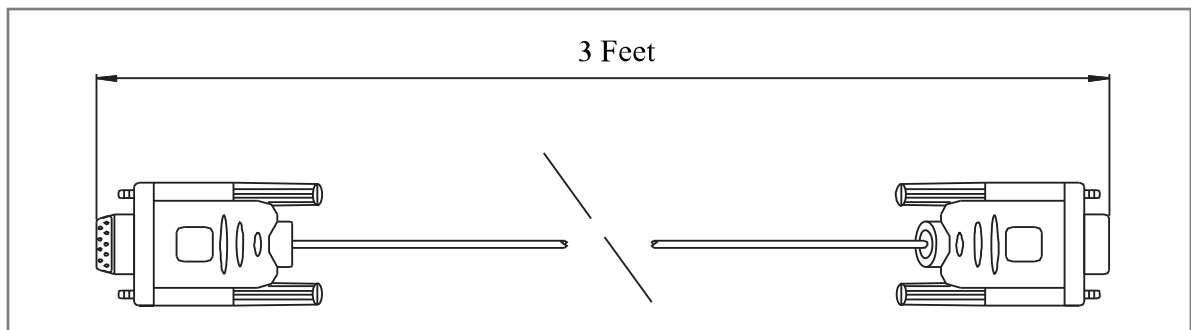

Fig 19: TEK-Clamp 1200A-100H Electrical Connections Cables Interface

4.1 Signal Strength

- Signal strength indicates the amplitude of receiving ultrasonic signals by a 3-digit number. [000] means there is no signal detected and [999] refers to the maximum signal strength that can be received.
- The following methods are recommended to obtain stronger signals:
 1. Relocate a more favourable location, if the current location is not good enough for a stable and reliable flow reading, or if the signal strength is lower than 700.
 2. Try to polish the outer surface of the pipe and apply more coupler to increase the signal strength.
 3. Adjust the transducers both vertically and horizontally while checking the varying signal strength, stop at the highest position, and then check the spacing of the transducers to make sure the spacing of the transducers.

4.1.1 Signal Quality

Signal quality is indicated by the Q value in the instrument. A higher Q value means high signal to noise ratio (SNR), which provide higher degree of accuracy in measurement. Under normal pipe condition, the Q value is in the range between 600-900, the higher the better.

Disadvantage of lower Q value is as follows:

1. Interference of other instruments and devices such as a powerful transmitter working nearby. Try to relocate the flow meter to a new place where the interference can be minimum. Bad sonic coupling for the transducers with the pipe.
2. Apply more coupler or clean the surface, etc. Pipes are difficult to be measured. Relocation is recommended.

4.2 Transmitter Connections

4.2.1 Basic Circuit of the Transmitter

The converter can supply the uncontrollable current to the coil in the sensor of electromagnetic flow meter. The head amplifier amplifies the electromotive force from the sensor and converts it into standard signals of current or frequency so that the signals can be used for displaying, controlling, and processing.

4.3 Digital Output

The transmitter has two output signals i.e., frequency and pulse output. The user can choose only one type of output.

4.3.1 The Connection of Digital Output

Digital output has two connected points i.e., digital output connected point and digital ground point,



CAUTION

- Make sure the sensor connected to the earth.
- Make sure the liquid is still when regulating instruments.
- The electrode and the liquid should be in contact for about 48 hours.

4.3.2 Key's Function

- Key's function in self- testing way

"Down" key	Down button cycles through data displayed on lower lines
"Up" key	Up button cycles through data displayed on lower lines
"Enter" key	Press it to come into the interface measuring
"Compound" & "Enter"	To enter parameter setting
Under measurement status, adjustment of the LCD contract	Push "Down" & "Compound" or "Up" & "Compound"

- Push "Down" & "Compound" or "Up" & "Compound"

"Down" key	Subtract 1 from the number above cursor
"Up" key	Plus 1 to the number above cursor
"Compound" & "Down"	To shift cursor to left
"Compound" & "Up"	To shift cursor to right
"Enter" key	To enter or exit the submenu, pressure for more than 2s to exit to measuring status



NOTE

When using the "Compound" key, you should press "Compound" key and "Up" key both or "Compound" key and "Down" key both.
To select the zero correction about the flow directly use "Down" or "Up" to Switch.

To set or correct working parameters, the converter should be running in Parameters Setting Way instead of Measuring Status.

- In Measuring Status, press "Compound" + "Enter" keys getting to the select of parameter and transfer password (0000).

- Correct the password with one of the new passwords that are provided by manufacturer. Finally, press the “Compound” +” Enter” keys to work in Parameters Setting Way.
- There are 6 Passwords in design and among them 4 for deferent operators in secret and 2 are fixed passwords for system operation.

4.3.3 Menu

- Parameters of converters can decide the running status, process and output ways as well as state of output. Correct option and setting of parameters can keep the converters running optimally and get higher accuracies of output both in display and in measurement.
- There are 6 grades of passwords for setting parameters function. Grades 1 to grade 5 of passwords are for users and grade 6 of password is for manufacturer. Users can reset their passwords of grades 1 to 4 in grade 5.
- Users can check converters parameters in any grade of password. However, if users want to change parameters of converters, deferent grade of parameters have to be used by the users.

4.3.4 Keypad

- The keypad of the flow meter has 16+2 keys.
- Keys 0 ~ 9 and • are keys to enter numbers.
- Key ▲/+ is the going UP key when the user wants to go to the upper menu window. It also works as ‘+’ key when entering numbers.
- Key ▼/- is the going DOWN key when the user wants to go to the lower menu window. It also works as the ‘-’ key when entering numbers.
- Key ◀ is the backspace key when the user wants go left or wants to backspace the left character that is located to the left of the cursor.
- Key **ENT** is the ENTER key for any input or selections.
- Key **MENU** is the key for the direct menu window jump over. Whenever the user wants to proceed to a certain menu window, the user can press this key followed by a 2-digit number.
- The **MENU** Key is shortened as the ‘M’ key hereafter when referring to menu windows
- The **ON** key is for the power on.
- The **OFF** key is for the power off.

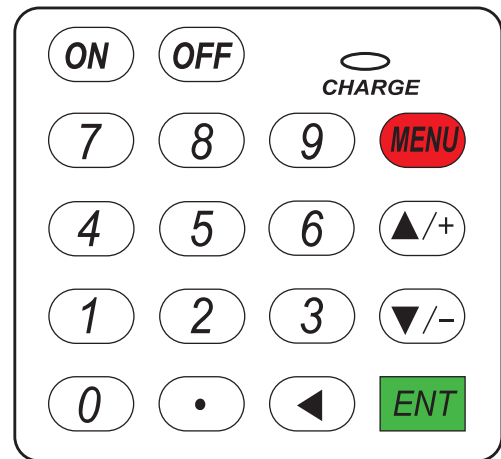

Fig 20: Keypad 1200A-100H

4.3.5 Menu Windows

The user interface of this flow meter comprises about 100 different menu windows that are numbered by M00, M01, M02 ... M99.

There are two methods to get into certain menu window:

- Direct jump in. The user can press the **MENU** key followed by a 2-digit number. For example, the menu window M11 is for setting up pipe outer diameter. Pressing **MENU 1 1** will display the M11 menu window immediately.
- Press ▲/+ (Up) or ▼/- (down) key. Pressing the ▲/+ key will show to the user the lower-numbered menu window. For example, if the current window is on M12, the display will go to window M11 after the ▲/+ key is pressed once.

- There are three different types of menu windows:
 1. Menu windows for number entering, e.g., M11 for setting up pipe outer diameter.
 2. Menu windows for option selection, e.g., M14 for the selection of pipe materials.
 3. Results display windows, e.g., window M00 for displaying Velocity, Flow Rate, etc.
- For number entering windows, the user can directly press the digit keys if the user wants to modify the value. For example, if the current window is on M11, and the user wants to enter 219.2345 as the pipe outer diameter, then, the following keys should be pressed:



- For option selection windows, the user should first press the **ENT** key to get into option selection mode. Then, use ▲/+ (Up), ▼/- (down) or digit key to select the right option. Consequently, press the **ENT** to make the selection.
- For example, assume your pipe material is stainless steel and you are currently on menu window M14 which is for the selection of pipe materials (if you are on a different window, you need press (1) (4) **MENU** first in order to enter into the M14 window.)
- You need to press the **ENT** key to get into the option selection mode. Then, either press the ▲/+ (Up) and ▼/- (down) keys to make the cursor on the line that displays **"1. Stainless Steel"**, or press (1) the key directly. At the end, press **ENT** again to make the selection.
- Generally, the **ENT** key must be pressed to get into the option selection mode for option modifications. If the **"Locked M47 Open"** message is indicated on the lowest line of the LCD display, it means that the modification operation is locked out. In such cases, the user should go to **M47** to have the instrument unlocked before any further modification can be made.

4.3.6 Menu Window List

- **M00~M09 windows** are suitable for viewing the instantaneous flow rate, net totalizer value, positive totalizer value, negative totalizer value, instantaneous flow velocity, date time, battery voltage and estimated working hours for the battery.
- **M10~M29 windows** have to be used for entering system parameters, such as pipe outer diameter, pipe wall thickness, liquid type, transducer type / model, transducer installation method, etc. Transducer installation spacing is also displayed on one of the windows.
- **M30~M38 windows** allow the user to enter the flow rate unit and to configure the totalizer. User can use these windows to select flow rate unit, such as cubic meter or litre, as well as to turn on / off each totalizer, or to zero the totalizers.
- **M40~M49 windows** are for setting response time, zeroing / calibrating the system and changing password.
- **M50~M53 windows** are for setting up the built-in logger.
- **M60-M78 windows** are for setting up timekeeper and displaying software version, system serial number ESN and alarms.
- **M82 window** is for viewing the totalizer.
- **M86~M89 windows** are useful to configure some parameters about the signal management, such as automatic control, power selection and receive window width
- **M90~M94 windows** are for displaying diagnostic data. Those data are very useful when doing a more accurate measurement.
- **M97~M99** are not setup windows but commands for window copy output and pipe parameters output.
- **M+0~M+8 windows** offer some additional functions, including a scientific calculator, display of the total working time, and display of the time and the flow rate when the device is turned on and turned off.

Other menu windows such as **M88** have no functions, or functions were cancelled because they are not applied to this version of the software. The major reason why the menu windows are arranged in this way is to make this version compatible with the previous ones. This will make things easier for a user that wants to switch from a previous version to the new one.

4.3.7 Steps to Configure the Parameters

1. Pipe outer diameter.
2. Pipe wall thickness.
3. Pipe materials.
4. Linear material and its sound speed and thickness shows half sentence what any linear.
5. For non-standard liquids, the sound speed of the liquid is also needed.
6. Generally, the Standard M1 clamp-on transducers is selected.
7. Generally, Transducer mounting methods are the V-method or Z-method is the common option.
8. Check the space displayed on M25 and install transducer accordingly.

For standard pipe materials and standard liquids, the following detailed step-by-step setup is recommended.

1. Press keys *MENU* diameter, and then press 11 **ENT** to enter M11 window to input the digits for the pipe outer key.
2. Press key ▼/- to enter M12 window to input the digits for the pipe outer diameter and then press **ENT** key.
3. Press key ▼/- (down) to enter M14 window, and press mode. Use keys ▲/+ (Up) and ▼/- (down) to scroll up and down to the intended pipe material, and then press **ENT**.
4. Press key ▼/- (down) to enter M16 window, press **ENT** key to enter the option selection mode, use keys ▲/+ (Up) and ▼/- (down) to scroll up and down to the liner material, and then press key. Select “No Liner”, if there is no liner.
5. Press key ▼/- (down) to enter M20 window, press **ENT** key to enter the option selection mode, use keys ▲/+ (Up) and ▼/- (down) to scroll up and down to the proper liquid, and then press **ENT** key
6. Press key ▼/- (down) to enter M23 window, press key to enter the option selection mode, **ENT** use keys ▲/+ (Up) and ▼/- (down) to scroll up and down to the proper transducer type, and then press **ENT** key.
7. Press key ▼/- (down) to enter M24 window, press use keys ▲/+ (Up) and ▼/- (down) to scroll up and down to the proper transducer mounting method, and then press **ENT** key
8. Press key ▼/- (down) to enter M25 window to install the transducers on the pipe, and then press key to go to M01 for the results.

Fig 13: Keypad 1200A-100H

The first-time users may need some time to get familiar with the operation. the user-friendly interface of the device makes the operation quite smooth and simple. You will soon find that it is very quick to configure the instrument with very little key pressing, since the interface allows the user to go to the desired operation directly without any extra steps.









The following tips will facilitate the operation of this instrument.

- When the current window is one between **M00** to **M09**, pressing a number key **x** will enter into the **M0x** window directly. For example, if the current window display is **M01**, pressing **7** leads to window **M07**.
- When the current window is one between **M00** to **M09**, pressing **ENT** key will lead to window **M90** for displaying diagnostic data. Press **ENT** key again to return to the previous window. Press the  key to go to window **M11**.
When the current window is **M25**, pressing **ENT** key will lead to window **M01**.

5 Menu Window Details

Menu Window No.	Function			
M00	Display POS (positive), NEG (negative) and NET (net) totalizer values. Display signal strength, signal quality and working status.			
M01	Display POS totalizer, instantaneous flow rate, velocity, signal strength, signal quality and working status.			
M02	Display NEG totalizer, instantaneous flow rate, velocity, signal strength, signal quality and working status.			
M03	Display NET totalizer, instantaneous flow rate, velocity, signal strength, signal quality and working status.			
M04	Display date and time, instantaneous flow rate, signal strength, signal quality and working status			
M05	Display date and time, velocity, signal strength, signal quality and working status.			
M06	Display the wave shape of the receiving signal.			
M07	Display the battery terminal voltage and its estimated lasting time.			
M08	Display all the detailed working status, signal strength, signal quality.			
M09	Display today's total NET flow, velocity, signal strength, signal quality and working status.			
M10	Window for entering the outer perimeter of the pipe.			
M11	Window for entering the outer diameter of the pipe Valid range: 0 to 6000mm.			
M12	Window for entering pipe wall thickness. Valid range: 0-55mm			
M13	Window for entering the inner diameter of the pipe. If pipe outer diameter and wall thickness are entered correctly, the inner diameter will be calculated automatically, thus no need to change anything in this window. Valid range: 0-6000mm			
M14	Window for selecting pipe material. Standard pipe materials (no need to enter the material sound speed) include:			
	carbon steel	stainless steel	cast iron	ductile iron
	copper	PVC	aluminium	asbestos
	fiberglass	Other		
M15	Window for entering the sound speed of non-standard pipe materials			

M16	Window for selecting the liner material. Select none for pipes without any liner. Standard liner materials (no need to enter liner sound speed) include:			
	Tar Epoxy	Rubber	Mortar	Polypropylene
	Polystyle	Polystyrene	Polyester	Polyethylene
	Ebonite	Teflon		
M17	Window for entering the sound speed of non-standard liner materials			
M18	Window for entering the liner thickness if there is a liner			
M19	Window for entering the roughness coefficient of the pipe inner surface			
M20	Window for selecting fluid type for standard liquids (no need to enter liquid sound speed) include:			
	Water	Sea Water	Kerosene	Gasoline
	Fuel oil	Crude Oil	Propane at -45C	Butane at 0C
	Other liquids	Diesel Oil	Castor Oil	Peanut Oil
	#90 Gasoline	#93 Gasoline	Alcohol	Hot water at 125C
M21	Window for entering the sound speed of non-standard liquids			
M22	Window for entering the viscosity of non-standard liquids			
M23	Window for selecting transducer type: There are 14 different types of transducers for selection. If the π type spool-piece transducers are used, the user needs to configure the 3 transducer parameters. Otherwise, the user needs to configure the 4 transducer parameters.			
M24	Window for selecting the transducer mounting methods Four methods can be selected			
	V-method	Z-method	N-method	W-method
M25	Display the transducer mounting spacing or distance			
M26	Entry to store the pipe parameters into the internal NVRAM (non-volatile memory)			
M27	Entry to read the previously saved pipe parameters			
M28	Entry to determine whether to keep the last correct value when poor signal condition occurs. YES, is the factory default			
M29	Window to set the threshold below which the receiving signal is defined as poor. Valid number: from 000 to 999. 0 is the factory default			
M30	Window for selecting unit system. 'Metric' is the factory default. The conversion from English to Metric or vice versa will not affect the unit for totalizers			
M31	Window for selecting flow rate unit system. Flow rate can be in			
	Cubic meter short for (m ³)	Litter (l)	Million USA gallon (mgl)	Cubic feet (cf) Oil barrel (ob)
	USA gallon (gal)	Imperial Gallon (igl)	USA liquid barrel (bal)	Imperial liquid barrel (ib)
	The flow unit in terms of time can be per day, per hour, per minute or per second. So there are 36 different flow rate units in total for selection.			
M32	Window for selecting the totalizers' unit			
M33	Window for setting the totalizer multiplying factor. The multiplying factor ranges from 0.001 to 10000			
M34	Turn on or turn off the NET totalizer			
M35	Turn on or turn off the POS totalizer			

M36	Turn on or turn off the NEG totalizer
M37	1. Totalizer reset
	2. Restore the factory default settings. Press  the key followed by the  key. Attention, it is recommended to make notes on the parameters before doing the restoration.
M38	Manual totalizer used for calibration. Press any key to start and press the key again to stop the totalizer.
M39	Language selection, Chinese or English.
M40	Flow rate damper setup. The damping parameter ranges from 0 to 999 seconds. 0 means there is no damping. Factory default is 10 seconds
M41	Zero flow rate (or low flow rate) cut-off to avoid invalid accumulation.
M42	Zero-point setup. Make sure the liquid in the pipe is not running while doing this setup.
M43	Clear the zero-point value and restore the factory default zero point.
M44	Set up a flow bias. Generally, this value should be 0.
M45	Flow rate scale factor. The factory default is '1'. Keep this value as '1' when no calibration has been made.
M46	Network address identification number (IDN). Any integer can be entered except 13(0DH, carriage return), 10 (0AH, line feeding), 42 (2AH), 38, 65535. Every set of the instrument in a network environment should have a unique IDN. Please refer to the chapter for communications
M47	System lock to avoid modification of the system parameters
M48	Not used
M49	Window for network communication test
M50	Window to set up the schedule-based data saving. Select the items to be saved.
M51	Window to set up the schedule for the schedule-based data saving
M52	Data output direction control.
	If 'To RS-232' is selected, all the data will be directed to the RS-232 interface If 'To buffer' is selected, the data will be stored into the built-in logger memory Allow user to clear data buffer
M53	Logger buffer viewer. It functions as a file editor. Use  ,  ,  and  keys to browse the buffer. If the logger is ON, the viewer will automatically refresh once new data are stored
M54	Not used
M55	Not used
M56	Not used
M57	Not used
M58	Not used
M59	Not used
M60	99 years calendar. Press  for modification. Use the  key to skip the digits that need no modification.
M61	Display Version information and Electronic Serial Number (ESN) that are unique for each flow meter. The user can use the ESN for instrumentation management
M62	RS-232 setup. Baud rate can be 75 to 115,200 bps
M63	Not used

M64	Not used
M65	Not used
M66	Not used
M67	Window to set up the frequency range (lower limit and upper limit) for the frequency output. Valid values: 0Hz-9999Hz. Factory default is 1-1001 Hz
M68	Window to set up the minimum flow rate which corresponds to the lower frequency limit of the frequency output
M69	Window to set up the maximum flow rate which corresponds to the upper frequency limit of the frequency output
M70	LCD display backlight control. The entered value indicates how many seconds the backlight will be on with every key pressing.
M71	LCD contrast control. The LCD will become darker when a small value is entered.
M72	Working timer. It can be reset by pressing ENT key, and then select YES.
M73	Alarm #1 lower threshold setup. Below this threshold the #1 Alarm will be triggered. There are two alarming methods. User must select the alarming output items from window M78 or M77
M74	Alarm #1 upper threshold setup
M75	Alarm #2 lower threshold setup
M76	Alarm #2 upper threshold setup
M77	Buzzer setup. If a proper input source is selected, the buzzer will beep when the trigger event occurs.
M78	OCT (Open Collector Output) setup by selecting a proper triggering source, the OCT circuit will close when the trigger event occurs
M79	Not used
M80	Not Used
M81	Not used
M82	Setup for daily totalizer, monthly totalizer and yearly totalizer
M83	Not used
M84	Not used
M85	Not used
M86	Not used
M87	Select transducer power between 1-10 (default 10)
M88	Set receive window start
M89	Set receive window end
M90	Display signal strength, signal quality and transit time ratio (upper right corner).
M91	Display the transit time ratio. The ratio value should be in the range of 100±3% if the entered pipe parameters are correct and the transducers are properly installed. Otherwise, the pipe parameters and the transducer installation should be checked.
M92	Display the estimated sound speed of the fluid in the pipe. If this value has an obvious difference with the actual fluid sound speed, the user is recommended to check if the pipe parameters are correct and if the transducer installation is good.
M93	Display the total transit time and delta time (transit time difference between upstream and downstream travelling)

M94	Display the Reynolds number and the pipe factor used by the flow rate measurement program. Note, the pipe factor is rarely used.
M95	Not used
M96	Not used
M97	Command to store the pipe parameters either in the built-in data logger or to the RS-232C serial interface
M98	Command to store the diagnostic information either in the built-in data logger or to the RS-232C serial interface
M99	Command to copy the current display either to the built-in data logger or to the RS-232C serial interface
M+0	View the last 64 records of power on and off events. The recorded information include the date and time as well as the corresponding flow rate when the power on or off occurs
M+1	Display the total working time of the instrument
M+2	Display the last power-off date and time
M+3	Display the last power-off flow rate
M+4	Display the total number of times the flow meter has been powered on and off
M+5	A scientific calculator for the convenience of field applications. All the values are in single accuracy. All the mathematic operators are selected from a list.
M+6	Velocity change setup
M+7	Protocol selection
M+8	Not used
M+9	Not used
M-0	Entry to hardware adjusting windows. Valid for the manufacturer only.

6 Troubleshooting

This section provides troubleshooting techniques for most common operating problems.

6.1 No Display

1. Check the power supply connection.
2. Check the power fuse for faults.
3. Check the contrast of LCD and adjust.

6.2 Exciting Alarm

1. Check the connection of the exciting cables.
2. Check the total resistance of sensor's exciting coil resistances (less than 150Ω).
3. If first and second points are OK, then the converter is faulty.

6.3 Empty Pipe Alarm

If measured fluid full of testing pipe of sensor:

1. Short circuit three connectors SIG 1, SIG 2, SGND of converter; if no "Empty Alarm" is displayed then the converter works. In this case, it is possible that the conductivity of

measured fluid may be limited, or the empty threshold of the empty pipe and the range of the empty pipe are incorrectly set.

2. Check if the signal cable is OK or not.
3. Check if the electro-poles are OK or not.
4. Let the flow be zero, then the displayed conductivity should be less than 100%.
5. Resistances of SIG1 to SGND and SIG2 to SGND are all less than 50kΩ (conductivity of water) during measurement operation. (Resistances should be measured by means of multi-meter with the pointer for a better understanding of charging well.)

6.4 Measure Flow Disallow

If measured fluid full of testing pipe of sensor, check if the signal cable is OK.

6.5 Error Messages After Switching On

Error Message	Reason	Countermeasure
ROM Testing Error	Software problem	(1) Restart the device
Segment Test Error		(2) Contact Tek-Trol LLC
Stored Data Error	The parameters entered by the user are not integrated	Press the ENTER key. All values are reset to default.
Date Time Error	Number error in the calendar	Initialise the calendar via window M61
Repeated reboot	Hardware problem	Contact Tek-Trol LLC

6.6 Further Errors and Countermeasures

1. When the device indicates 0.0000 even though there is a volume flow and an “R” glows in the display and the signal quality Q is ok, there must be a different error. In many cases, this means that the zero point has been set incorrectly. Go to menu M432 and reset the zero point.
2. The displayed volume flow is obviously too low or too high:
 - a) Probably, the volume flow in window M44 has been entered manually. Set this value to “0”.
 - b) Problems with the sensor installation
 - c) Possibly, the display was set to “0” via M42 despite an existing volume flow. Repeat the zero-point setting and make sure that there is no flow in the pipe.
3. The real battery life is shorter than the value stated in M07.
 - a) The battery has exceeded its life cycle.
 - b) The battery has not been charged completely or the charging procedure has been interrupted too frequently. Charge the battery again. If the problem persists, contact Tek-Trol LLC.
 - c) When the battery voltage is between 3.70 and 3.90 V, discrepancies between the estimated and the actual transit time can occur.

6.7 Further Errors and Countermeasures

Error codes are indicated by a single letter in the lower right corner of the display. However, these only occur in the menus M00, M01, M02, M03, M90 and M08. The following chart shows the error codes and countermeasures.

Error code	Message in window M08	Reason	Countermeasure
R	System Normal	No error	-----
I	Detect No Signal	(1) No signal (2) Sensors installed improperly (3) Too much fouling (4) Liner too thick (5) Sensor cable not properly connected	(1) Change measuring location (2) Clean measuring location (3) Check the cables
J	Hardware Error	Hardware problem	Contact Tek-Trol LLC
H	Poor Signal Detected	(1) Poor signal (2) Sensors installed improperly (3) Too much fouling or contamination (4) Liner too thick (5) Sensor cable not properly connected	(1) Change measuring location (2) Clean measuring location (3) Check the cables (4) Check the contact gel
Q	Frequency Output Over	The output frequency is outside the permitted range	Check the values in the windows M67, M68 and M69. Enter higher values in window M69
F	System RAM Error Date Time Error CPU or IRQ Error ROM Parity Error	(1) Temporary Problems with the RAM or RTC (2) Permanent Problems with the hardware	(1) Restart the device (2) Contact Tek-Trol LLC
1 2 3	Adjusting Gain	The device is currently re-setting the signal gain; the number indicates the current work progress	-----
K	Empty pipe	(1) No liquid in the pipeline (2) Setting error in menu M29	(1) Choose a pipe that contains liquid (2) Enter "0" in window M29.

7 Appendix

7.1 Tables: Pipe Size

7.1.1 Copper - Standard Pipe Size Charts:

Classification: The copper tube is classified into four distinct specifications based on the wall thickness for a specific outside diameter. The tables given underneath are reference dimensions dependent on application:

Size / Nom. Dia. (Outside)	Nom. Wall Thickness	Max. Working Pressures*			Usage: General engineering, heating, gas reticulation, sanitary plumbing, underground works, and heavy-duty requirements including hot and cold-water supply
		Half Hard	Hard	Annealed	
inch(mm)	inch(mm)	bar+ (psi)	bar+ (psi)	bar+ (psi)	
¼" (6)	1/32" (0.8)	188 (2726)	223 (3234)	144 (2088)	
5/16" (8)	1/32" (0.8)	136 (1972)	161 (2335)	105 (1522)	
3/8" (10)	1/32" (0.8)	106 (1537)	126 (1827)	82 (1189)	
7/16" (12)	1/32" (0.8)	87 (1261)	104 (1508)	67 (971)	
½" (15)	1/32" (1.0)	87 (1261)	104 (1508)	67 (971)	
11/16" (18)	1/32" (1.0)	72 (1044)	85 (1232)	55 (797)	
7/8" (22)	1/32" (1.2)	69 (1000)	84 (1218)	53 (768)	
1 1/8" (28)	1/32" (1.2)	55 (797)	65 (942)	42 (609)	
1 3/8" (35)	1/16" (1.5)	54 (783)	65 (942)	41 (594)	
1 11/16" (42)	1/16" (1.5)	45 (652)	54 (783)	34 (493)	
2 1/8" (54)	1/16" (2.0)	47 (681)	56 (812)	36 (522)	
2 5/8" (66.7)	1/16" (2.0)	37 (536)	45 (652)	28 (406)	
3 1/32" (76.1)	1/16" (2.0)	33 (478)	39 (565)	25 (362)	
4 5/16" (108)	1/16" (2.5)	29 (420)	34 (493)	22 (319)	
*Based on designated temp. at 149°F					ADDED TOUGHNESS & DURABILITY

Size / Nom. Dia. (Outside)	Nom. Wall Thickness	Max. Working Pressures*			Usage: General purpose applications, sanitation, central heating, and above-ground services including drinking water supply, hot and cold-water systems.
		Half Hard	Hard	Annealed	
inch (mm)	inch (mm)	bar+ (psi)	bar+ (psi)	bar+ (psi)	
¼" (6)	1/32" (0.6)	133 (1929)	161 (2335)	102 (1479)	
5/16" (8)	1/32" (0.6)	97 (1406)	118 (1711)	75 (1087)	
3/8" (10)	1/32" (0.6)	77 (1116)	93 (1348)	59 (855)	
7/16" (12)	1/32" (0.6)	63 (913)	76 (1102)	48 (696)	
1/2" (15)	1/32" (0.7)	58 (841)	71 (1029)	45 (652)	
11/16" (18)	1/32" (0.8)	56 (812)	67 (971)	43 (623)	
7/8" (22)	1/32" (0.9)	51 (739)	62 (899)	39 (565)	
1 1/8" (28)	1/32" (0.9)	40 (580)	48 (696)	31 (449)	
1 3/8" (35)	1/16" (1.2)	42 (609)	51 (739)	33 (478)	
1 11/16" (42)	1/16" (1.2)	35 (507)	43 (623)	27 (391)	
2 1/8" (54)	1/16" (1.2)	27 (391)	33 (478)	21 (304)	
2 5/8" (66.7)	1/16" (1.2)	20 (290)	27 (391)	17 (246)	
3 1/32" (76.1)	1/16" (1.5)	24 (348)	29 (420)	18 (261)	
4 5/16" (108)	1/16" (1.5)	17 (246)	20 (290)	13 (188)	
5 ¼" (133)	1/16" (1.5)	14 (203)	17 (246)	10 (145)	
6 ¼" (159)	1/16" (2.0)	15 (217)	18 (261)	12 (174)	
*Based on designated temp. at 149°F					ECONOMICAL AND STRONG

Size / Nom. Dia. (Outside)	Nom. Dia. (Outside)	Nom. Wall Thickness	Max. Working Pressures*	Usage: General purpose applications, sanitation, central heating, and above-ground services including drinking water supply, hot and cold-water systems.
inch (mm)	inch (mm)	inch (mm)	bar+ (psi)	
1/4" (6)	1/4" (6)	1/64" (0.5)	113 (1638)	
5/16" (8)	5/16" (8)	1/64" (0.5)	98 (1421)	
3/8" (10)	3/8" (10)	1/64" (0.5)	78 (1131)	
7/16" (12)	7/16" (12)	1/64" (0.5)	64 (928)	
1/2" (15)	1/2" (15)	1/64" (0.5)	50 (725)	
11/16" (18)	11/16" (18)	1/32" (0.6)	50 (725)	
7/8" (22)	7/8" (22)	1/32" (0.6)	41 (594)	
1 1/8" (28)	1 1/8" (28)	1/32" (0.6)	32 (464)	
1 3/8" (35)	1 3/8" (35)	1/32" (0.7)	30 (435)	
1 11/16" (42)	1 11/16" (42)	1/32" (0.8)	28 (406)	
2 1/8" (54)	2 1/8" (54)	1/32" (0.9)	25 (362)	
2 5/8" (66.7)	2 5/8" (66.7)	1/32" (1.0)	20 (290)	
3 1/32" (76.1)	3 1/32" (76.3)	1/16" (1.2)	19 (275)	
4 5/16" (108)	4 5/16" (108)	1/16" (1.2)	17 (264)	
5 1/4" (133)	5 1/4" (133)	1/16" (1.5)	16 (232)	
6 1/4" (159)	6 1/4" (159.5)	1/16" (1.5)	15 (217)	

*Based on designated temp. at 149°F

LOW-COST UTILITY RANGE

7.1.2 PVC - Standard Pipe Size Charts:

Pipe inch (mm)	OD		PN6 Wall Thickness		I/D inch (mm)	PN9 Wall Thickness		I/D inch (mm)	PN12 Wall Thickness		ID inch (mm)	PN12 Wall Thickness		I/D inch (mm)
	inch (mm)	inch (mm)	Min	Max		Min	Max		Min	Max		Min	Max	
1/2" (15)	53/64" (21.20)	27/32" (21.50)	-	-	-	-	-	-	-	-	-	1/16" (1.40)	1/16" (1.70)	23/32" (18.25)
3/4" (20)	1 3/64" (26.60)	1 1/16" (26.90)	-	-	-	-	-	-	1/16" (1.40)	1/16" (1.70)	15/16" (23.65)	1/16" (1.70)	5/64" (2.10)	29/32" (22.95)
1" (25)	1 5/16" (33.40)	1 1/64" (33.70)	-	-	-	1/16" (1.40)	1.70 (1/16")	1 13/64" (30.45)	1/16" (1.70)	5/64" (2.10)	1 11/64" (29.75)	3/32" (2.50)	1/8" (3.00)	1 7/64" (28.05)
1 1/4" (32)	1 21/32" (42.10)	143/64" (42.40)	-	-	-	1/16" (1.70)	2.10 (5/64")	1 33/64" (38.45)	3/32" (2.20)	7/64" (2.60)	1 15/32" (37.45)	1/8" (3.20)	9/64" (3.70)	1 25/64" (35.35)
1 1/2" (40)	1 57/64" (48.10)	19/32" (48.40)	1/16" (1.40)	1/16" (1.70)	1 51/64" (45.15)	5/64" (1.90)	2.10 (5/64")	1 47/64" (44.05)	3/32" (2.50)	1/8" (3.00)	1 11/16" (42.75)	9/64" (3.60)	11/64" (4.20)	1 19/32" (40.45)
2" (50)	2 3/8" (60.20)	23/8" (60.50)	1/16" (1.60)	5/64" (2.00)	2 15/64" (56.75)	3/32" (2.40)	2.80 (7/64")	2 11/64" (55.15)	1/8" (3.10)	9/64" (3.60)	2 7/64" (53.65)	3/16" (4.60)	13/64" (5.30)	1 63/64" (50.45)
2 1/2" (65)	75.20 (2 61/64")	231/32" (75.50)	-	-	-	-	-	-	5/32" (3.90)	11/64" (4.50)	2 41/64" (66.95)	-	-	-
3 3/16" (80)	3 31/64" (88.70)	333/64" (89.10)	3/32" (2.40)	7/64" (2.80)	3 19/64" (83.70)	9/64" (3.50)	4.10 (5/32")	3 13/64" (81.30)	3/16" (4.60)	13/64" (5.30)	3 7/64" (79.00)	-	-	-
4" (100)	4 31/64" (114.10)	433/64" (114.50)	1/8" (3.00)	9/64" (3.50)	4 1/2" (107.80)	11/64" (4.50)	5.20 (13/64")	4 1/8" (104.60)	15/64" (5.90)	17/64" (6.70)	4" (101.70)	-	-	-
5" (125)	5 33/64" (140.00)	517/32" (140.40)	-	-	-	7/32" (5.50)	6.30 (1/4")	5 1/16" (128.40)	9/32" (7.20)	5/16" (8.10)	4 59/64" (124.90)	-	-	-
6" (150)	6 19/64" (160.00)	6 5/16" (160.50)	11/64" (4.20)	11/64" (4.20)	5 61/64" (151.25)	1/4" (6.30)	7.10 (9/32")	5 25/32" (146.85)	21/64" (8.30)	23/64" (9.30)	5 39/64" (142.65)	15/32" (12.0)	33/64" (13.60)	5 16/64" (134.65)
7" (175)	7 7/8" (200.00)	7 57/64" (200.50)	-	-	-	9/32" (7.10)	8.00 (5/16")	7 19/64" (185.15)	-	-	-	-	-	-
7 1/2" (177)	6 31/32" (177.10)	6 63/64" (177.60)	-	-	-	-	-	-	23/64" (9.20)	13/32" (10.30)	6 7/32" (157.85)	-	-	-

8" (200)	8 ⁵⁵ / ₆₄ " (225.00)	8 ⁷ / ₈ " (225.60)	7 ⁷ / ₃₂ " (5.40)	15 ¹⁵ / ₆₄ " (6.10)	8 ²⁷ / ₆₄ " (213.80)	5 ⁵ / ₁₆ " (7.90)	11 ¹¹ / ₃₂ " (8.90)	8 ¹³ / ₆₄ " (208.50)	13 ¹³ / ₃₂ " (10.50)	29 ²⁹ / ₆₄ " (11.70)	8" (203.10)	-	-	-
8 ⁷ / ₈ " (225)	9 ²⁷ / ₃₂ " (250.00)	9 ⁷ / ₈ " (250.70)	-	-	-	-	-	-	29 ²⁹ / ₆₄ " (11.60)	33 ³³ / ₆₄ " (13.00)	8 ⁵⁷ / ₆₄ " (225.75)	-	-	-
10" (250)	11 ¹ / ₃₂ " (280.00)	11 ³ / ₈ " (288.80)	-	-	-	-	-	-	33 ³³ / ₆₄ " (13.00)	37 ³⁷ / ₆₄ " (14.50)	10" (252.90)	-	-	-
12" (300)	12 ¹³ / ₃₂ " (315.00)	12 ⁷ / ₁₆ " (315.90)	-	-	-	-	-	-	37 ³⁷ / ₆₄ " (14.70)	41 ⁴¹ / ₆₄ " (16.30)	11 ¹³ / ₆₄ " (284.45)	-	-	-

7.1.3 Steel - Standard Pipe Size Charts:

Standard ANSI Pipe Size Chart for Carbon Steel and Stainless-Steel Pipe

Nominal Pipe Size	Outer Diameter	Wall Thickness	ANSI B 36.10 Carbon Steel	ANSI B 36.10 Carbon Steel	ANSI B 36.19 Stainless Steel
in (mm)	decimal in (mm)	decimal in (mm)	Wall Thicken.	Sch. Number	Sch. Number
1/8" (3)	0.405" (10)	0.05" (1.2)	-	-	10S
		0.07" (1.7)	STD	40	40S
		0.10" (2.4)	XS	80	80S
1/4" (6)	0.540" (14)	0.07" (1.7)	-	-	10S
		0.09" (2.2)	STD	40	40S
		0.12" (3)	XS	80	80S
3/8" (10)	0.675" (17)	0.07" (1.7)	-	-	10S
		0.10" (2.3)	STD	40	40S
		0.13" (3.2)	XS	80	80S
1/2" (15)	0.840" (21)	0.07" (1.7)	-	-	5S
		0.09" (2.1)	-	-	10S
		0.11" (3.2)	STD	40	40S
		0.15" (3.7)	XS	80	80S
		0.19" (4.7)	-	160	-
		0.30" (7.5)	XXS	-	-
3/4" (19)	1.050" (26)	0.07" (1.7)	-	-	5S
		0.09" (2.1)	-	-	10S
		0.12" (2.9)	STD	40	40S
		0.16" (3.9)	XS	80	80S
		0.22" (3.9)	-	160	-
		0.31" (7.8)	XXS	-	-
1" (25)	1.315" (33)	0.07" (1.7)	-	-	5S
		0.11" (3.2)	-	-	10S
		0.14" (3.4)	STD	40	40S
		0.18" (4.5)	XS	80	80S
		0.25" (6.4)	-	160	-
		0.36" (9.1)	XXS	-	-
1 1/4" (32)	1.660" (42)	0.07" (1.7)	-	-	5S
		0.11" (3.2)	-	-	10S
		0.14" (3.6)	STD	40	40S
		0.20" (4.9)	XS	80	80S
		0.25" (6.4)	-	160	-
		0.39" (9.7)	XXS	-	-
1 1/2" (139.7)	1.900" (48)	0.07" (1.7)	-	-	5S
		0.11" (3.2)	-	-	10S
		0.15" (3.7)	STD	40	40S
		0.20" (5.1)	XS	80	80S

		0.29" (7.1)	-	160	-
		0.40" (10.2)	XXS	-	-
2" (50)	2.375" (60)	0.07" (1.7)	-	-	5S
		0.11" (3.2)	-	-	10S
		0.16" (3.9)	STD	40	40S
		0.22" (5.5)	XS	80	80S
		0.35" (8.7)	-	160	-
		0.44" (11.1)	XXS	-	-
2 1/2" (65)	2.875" (73)	0.09" (2.1)	-	-	5S
		0.12" (3)	-	-	10S
		0.21" (5.2)	STD	40	40S
		0.28" (7)	XS	80	80S
		0.38" (9.5)	-	160	-
		0.56" (14)	XXS	-	-
3" (75)	3.500" (89)	0.09" (2.1)	-	-	5S
		0.12" (3)	-	-	10S
		0.22" (5.5)	STD	40	40S
		0.30" (7.6)	XS	80	80S
		0.44" (11.1)	-	160	-
		0.60" (15.2)	XXS	-	-
3 1/2" (85)	4.000" (101)	0.09" (2.1)	-	-	5S
		0.12" (3)	-	-	10S
		0.23" (5.7)	STD	40	40S
		0.32" (8.1)	XS	80	80S
		0.64" (16.2)	XXS	-	-
4" (100)	4.500" (114)	0.09" (2.1)	-	-	5S
		0.12" (3)	-	-	10S
		0.24" (6)	STD	40	40S
		0.34" (8.6)	XS	80	80S
		0.44" (12.7)	-	120	-
		0.54" (13.5)	-	160	-
5" (125)	5.536" (140)	0.68" (17.1)	XXS	-	-
		0.11" (3.2)	-	-	5S
		0.14" (3.4)	-	-	10S
		0.26" (6.6)	STD	40	40S
		0.38" (9.5)	XS	80	80S
		0.50" (12.7)	-	120	-
6" (150)	6.625" (168)	0.63" (15.9)	-	160	-
		0.75" (19)	XXS	-	-
		0.11" (3.2)	-	-	5S
		0.14" (3.4)	-	-	10S
		0.28" (7.1)	STD	40	40S
		0.44" (11)	XS	80	80S
8" (200)	8.625" (219)	0.57" (14.3)	-	120	-
		0.72" (18.3)	-	160	-
		0.87" (3.4)	XXS	-	-
		0.11" (3.2)	-	-	5S
		0.15" (21.9)	-	-	10S
		0.25" (6.4)	-	20	-
		0.28" (7)	-	30	-
		0.33" (11)	STD	40	40S
		0.41" (10.3)	-	60	-
		0.50" (12.7)	XS	80	80S
0.60" (15.1)	-	100	-		
0.72" (18.3)	-	120	-		
0.82" (20.6)	-	140	-		

10" (250)	10.750" (273)	0.88" (22.2)	XXS	-	-
		0.91" (23)	-	160	-
		0.14" (3.4)	-	-	5S
		0.17" (4.2)	-	-	10S
		0.25" (6.4)	-	20	-
		0.31" (7.8)	-	30	-
		0.37" (9.3)	STD	40	40S
		0.50" (12.7)	XS	60	80S
		0.60" (15)	-	80	-
		0.72" (18.3)	-	100	-
		0.85" (21.4)	-	120	-
		1.00" (25.4)	XXS	140	-
12" (300)	12.750" (324)	0.16" (4)	-	-	5S
		0.18" (4.6)	-	-	10S
		0.25" (6.4)	-	20	-
		0.33" (8.4)	-	30	-
		0.38" (9.5)	-	-	40S
		0.41" (9.5)	-	40	-
		0.50" (10.3)	XS	-	80S
		0.57" (14.3)	-	60	-
		0.69" (17.5)	-	80	-
		0.85" (21.4)	-	100	-
		1.00" (25.4)	XXS	120	-
		1.13" (28.6)	-	140	-
14" (350)	14.000" (355)	0.16" (4)	-	-	5S
		0.19" (4.8)	-	-	10S
		0.25" (6.4)	-	10	-
		0.32" (7.9)	-	20	-
		0.38" (9.5)	-	30	-
		0.44" (11.1)	-	40	-
		0.50" (12.7)	XS	-	-
		0.60" (15)	-	60	-
		0.63" (15.9)	XXS	-	-
		0.75" (19)	-	80	-
		0.94" (23.8)	-	100	-
		1.10" (27.8)	-	120	-
		1.25" (31.8)	-	140	-
		1.41" (35.7)	-	160	-
16" (400)	16.000" (406)	0.17" (4.2)	-	-	5S
		0.19" (4.8)	-	-	10S
		0.25" (6.4)	-	10	-
		0.32" (7.9)	-	20	-
		0.38" (9.5)	-	-	-
		0.50" (12.7)	STD	30	-
		0.66" (16.7)	XS	40	-
		0.85" (21.4)	-	60	-
		1.04" (26.2)	-	80	-
		1.22" (31)	-	100	-
		1.44" (36.6)	-	140	-
		1.55" (39.3)	-	160	-
18" (450)	18.000" (457)	0.17" (4.2)	-	-	5S
		0.19" (4.8)	-	-	10S
		0.25" (6.4)	-	10	-
		0.32" (7.9)	-	20	-
		0.38" (9.5)	STD	-	-
		0.44" (11.1)	-	30	-

		0.50" (12.7)	XS	-	-
		0.57" (14.3)	-	40	-
		0.75" (19)	-	60	-
		0.94" (23.8)	-	80	-
		1.16" (28.6)	-	100	-
		1.38" (34.9)	-	120	-
		1.57" (39.7)	-	140	-
		1.79" (45.2)	-	160	-
		20" (500)	20.000" (508)	0.19" (4.8)	-
0.22" (3.9)	-			-	10S
0.25" (6.4)	-			10	-
0.38" (9.5)	STD			20	-
0.50" (12.7)	XS			30	-
0.60" (15)	-			40	-
0.82" (20.6)	-			60	-
1.04" (26.2)	-			80	-
1.29" (32.5)	-			100	-
1.50" (38.1)	-			120	-
1.75" (44.4)	-			140	-
1.97" (50)	-			160	-
22" (550)	22.000" (559)	0.19" (4.8)	-	-	5S
		0.22" (3.9)	-	-	10S
		0.25" (6.4)	-	10	-
		0.38" (9.5)	STD	20	-
		0.50" (12.7)	-	40	-
		0.88" (22.2)	-	60	-
		1.13" (28.6)	-	80	-
		1.38" (34.9)	-	100	-
		1.63" (41.3)	-	120	-
		1.88" (41.3)	-	140	-
		2.22" (56.3)	-	160	-
		24" (600)	24.000" (610)	0.22" (3.9)	-
0.25" (6.4)	-			-	10S
0.38" (9.5)	-			10	-
0.50" (12.7)	STD			20	-
0.57" (14.3)	XS			-	-
0.69" (17.5)	-			30	-
0.97" (24.6)	-			60	-
1.22" (31)	-			80	-
1.54" (38.9)	-			100	-
1.82" (46)	-			120	-
2.07" (52.4)	-			140	-
2.35" (59.5)	-			160	-
26" (650)	26.000" (660)	0.32" (7.9)	-	10	-
		0.38" (9.5)	STD	-	-
		0.50" (12.7)	XS	20	-
28" (700)	28.000" (711)	0.32" (7.9)	-	10	-
		0.38" (9.5)	STD	-	-
		0.50" (12.7)	XS	20	-
		0.63" (15.9)	-	30	-
30" (750)	30.000" (762)	0.25" (6.4)	-	-	5S
		0.32" (7.9)	-	10	10S
		0.38" (9.5)	STD	-	-
		0.50" (12.7)	XS	20	-
		0.63" (15.9)	-	30	-
		0.75" (19)	-	40	-

32" (800)	32.000" (813)	0.32" (7.9)	-	10	-
		0.38" (9.5)	STD	-	-
		0.50" (12.7)	XS	20	-
		0.63" (15.9)	-	30	-
		0.69" (17.5)	-	40	-
34" (850)	34.000" (864)	0.35" (8.7)	-	10	10S
		0.38" (9.5)	STD	-	-
		0.50" (12.7)	XS	20	-
		0.63" (15.9)	-	30	-
		0.69" (17.5)	-	40	-
36" (900)	36.000" (914)	0.32" (7.9)	-	10	10S
		0.38" (9.5)	STD	-	-
		0.50" (12.7)	XS	20	-
		0.63" (15.9)	-	30	-
		0.75" (19)	-	40	-
42" (1050)	42.000" (1067)	0.38" (9.5)	STD	-	-
		0.50" (12.7)	XS	20	-
		0.63" (15.9)	-	30	-
		0.75" (19)	-	40	-
48" (1200)	48.000" (1219)	0.38" (9.5)	-	-	-
		0.05" (1.2)	-	-	-

Table: Standard ANSI Pipe Size Data for Carbon Steel and Stainless-Steel Pipe

7.1.4 Cast Iron Pipe - Standard Pipe Size Charts: Standard Classes of Cast Iron Pipe

Nominal Pipe Size	Class A		Class B		Class C		Class D	
	Outer Diameter	Wall Thickness	Outer Diameter	Wall Thickness	Outer Diameter	Wall Thickness	Outer Diameter	Wall Thickness
In (mm)	In (mm)	In (mm)	In (mm)	In (mm)	In (mm)	In (mm)	In (mm)	In (mm)
3" (76.2)	3.80" (97)	0.39" (10)	3.96" (101)	0.42" (11)	3.96" (101)	0.45" (11)	3.96" (101)	0.48" (12)
4" (101.6)	4.80" (122)	0.42" (11)	5.00" (127)	0.45" (11)	5.00" (127)	0.48" (12)	5.00" (127)	0.52" (13)
6" (152.4)	6.90" (175)	0.44" (11)	7.10" (180)	0.48" (12)	7.10" (180)	0.51" (13)	7.10" (180)	0.55" (14)
8" (203.2)	9.05" (230)	0.46" (12)	9.05" (230)	0.51" (13)	9.30" (236)	0.56" (14)	9.30" (236)	0.60" (15)
10" (254.0)	11.10" (282)	0.50" (13)	11.10" (282)	0.57" (14)	11.40" (290)	0.62" (16)	11.40" (290)	0.68" (17)
12" (304.8)	13.20" (335)	0.54" (14)	13.20" (335)	0.62" (16)	13.50" (343)	0.68" (17)	13.50" (343)	0.75" (19)
14" (355.6)	15.30" (388)	0.57" (14)	15.30" (389)	0.66" (17)	15.65" (398)	0.74" (19)	15.65" (17)	0.82" (21)
16" (406.4)	7.40" (188)	0.60" (15)	17.40" (442)	0.70" (18)	17.80" (452)	0.80" (20)	17.80" (452)	0.89" (23)
18" (457.2)	19.50" (495)	0.64" (16)	19.50" (495)	0.75" (20)	19.92" (506)	0.87" (22)	19.92" (506)	0.96" (24)
20" (508)	21.60" (549)	0.67" (17)	21.60" (549)	0.80" (20)	22.06" (560)	0.92" (23)	22.06" (560)	1.03" (26)
24" (609.6)	25.80" (655)	0.76" (19)	25.80" (655)	0.89" (23)	26.32" (669)	1.05" (27)	26.32" (669)	1.16" (29)
30" (762)	31.74" (806)	0.88" (22)	32.00" (813)	1.03" (26)	32.40" (823)	1.20" (30)	32.74" (832)	1.37" (35)
32" (812.8)	37.96" (964)	0.99" (25)	38.30" (973)	1.15" (29)	38.70" (983)	1.36" (35)	39.16" (995)	1.58" (40)
42" (1066.8)	44.20" (1123)	1.10" (28)	44.50" (1130)	1.28" (33)	45.10" (1146)	1.54" (39)	45.58" (1158)	1.78" (45)
48" (1219.2)	50.50" (1283)	1.26" (32)	50.80" (1290)	1.42" (36)	51.40" (1306)	1.71" (43)	51.98" (1320)	1.99" (50)
54" (1371.6)	56.66" (1439)	1.35" (34)	57.10" (1450)	1.55" (39)	57.80" (1468)	1.90" (48)	58.40" (1483)	2.23" (57)
60" (1524.0)	62.80" (1595)	1.39" (35)	63.40" (1610)	1.67" (42)	64.20" (1631)	2.00" (51)	64.80" (1646)	2.38" (60)
72" (1828.8)	75.34" (1914)	1.62" (41)	76.00" (1930)	1.95" (42)	76.88" (1953)	2.39" (61)	-	-
84" (2133.6)	87.54" (2224)	1.72" (44)	88.50" (2248)	2.22" (57)	-	-	-	-

Nominal Pipe Size	Class E		Class F		Class G		Class H	
	Outer Diameter	Wall Thickness	Outer Diameter	Wall Thickness	Outer Diameter	Wall Thickness	Outer Diameter	Wall Thickness
In (mm)	In (mm)	In (mm)	In (mm)	In (mm)	In (mm)	In (mm)	In (mm)	In (mm)
6" (152.4)	7.22" (183)	0.58" (15)	7.22" (183)	0.61" (15)	7.38" (187)	0.65" (17)	7.38" (187)	0.69" (18)
8" (203.2)	9.42" (239)	0.66" (17)	9.42" (239)	0.66" (17)	9.60" (244)	0.75" (19)	9.60" (244)	0.80" (20)
10" (254.0)	11.60" (295)	0.74" (19)	11.60" (295)	0.80" (20)	11.84" (301)	0.86" (22)	11.84" (301)	0.92" (23)
12" (304.8)	13.78" (350)	0.82" (21)	13.78" (350)	0.89" (23)	14.08" (358)	0.97" (25)	14.08" (358)	1.04" (26)
14" (355.6)	15.98" (406)	0.90" (23)	15.98" (406)	0.99" (25)	16.32" (415)	1.07" (27)	16.32" (415)	1.16" (29)
16" (406.4)	18.16" (461)	0.90" (23)	18.16" (462)	1.08" (27)	18.54" (471)	1.18" (30)	18.54" (471)	1.27" (32)
18" (457.2)	20.34" (517)	1.07" (27)	20.34" (517)	1.17" (30)	20.78" (528)	1.28" (33)	20.78" (528)	1.39" (35)
20" (508)	22.54" (573)	1.15" (29)	22.54" (573)	1.27" (32)	23.02" (585)	1.39" (35)	23.02" (585)	1.51" (38)
24" (609.6)	26.90" (683)	1.31" (33)	26.90" (683)	1.45" (37)	27.76" (705)	1.75" (44)	27.76" (705)	1.88" (48)
30" (762)	33.10" (841)	1.55" (39)	33.46" (850)	1.73" (44)	-	-	-	-
32" (812.8)	39.60" (1006)	1.80" (46)	40.04" (1017)	2.02" (51)	-	-	-	-

7.1.5 Ductile Iron Pipe - Standard Pipe Size Charts:

Nominal Pipe Size	Outer Diameter	Pipe Wall Thickness						
		Class	Class	Class	Class	Class	Class	Class
		50	51	52	53	54	55	56
in (mm)	in (mm)	in (mm)	in (mm)	in (mm)	in (mm)	in (mm)	in (mm)	in (mm)
3" (76.2)	3.96" (100)	-	0.25" (6)	0.28" (7)	0.31" (8)	0.43" (11)	0.37" (9)	0.40" (10)
4" (101.6)	4.80" (121)	-	0.26" (7)	0.29" (7)	0.32" (8)	0.45" (11)	0.38" (10)	0.41" (10)
6" (152.4)	6.90" (175)	0.25" (6)	0.28" (7)	0.31" (8)	0.34" (7)	0.37" (9)	0.40" (10)	0.43" (11)
8" (203.2)	9.05" (229)	0.27" (7)	0.30" (8)	0.33" (8)	0.36" (9)	0.39" (10)	0.42" (11)	0.45" (11)
10" (254)	11.10" (281)	0.29" (7)	0.32" (8)	0.35" (9)	0.38" (10)	0.44" (11)	0.47" (12)	-
12" (304.8)	13.20" (335)	0.31" (8)	0.34" (9)	0.37" (9)	0.40" (10)	0.43" (11)	0.46" (12)	0.49" (12)
14" (355.6)	15.30" (388)	0.33" (8)	0.36" (9)	0.39" (10)	0.42" (11)	0.45" (11)	0.48" (12)	0.51" (13)
16" (406.4)	17.40" (441)	0.34" (9)	0.37" (9)	0.40" (10)	0.43" (11)	0.46" (12)	0.49" (12)	0.52" (13)
18" (457.2)	19.50" (495)	0.35" (9)	0.38" (10)	0.41" (10)	0.44" (11)	0.47" (12)	0.50" (13)	0.53" (13)
20" (508)	21.60" (548)	0.36" (9)	0.39" (10)	0.42" (11)	0.45" (11)	0.48" (12)	0.51" (13)	0.54" (14)
24" (609.6)	25.80" (655)	0.38" (10)	0.41" (10)	0.44" (11)	0.47" (12)	0.50" (13)	0.53" (13)	0.56" (14)
30" (762)	32.00" (812)	-	-	-	0.51" (13)	0.55" (13)	0.59" (15)	0.63" (16)
32" (812.8)	38.30" (972)	-	-	-	0.58" (15)	0.63" (16)	0.68" (17)	0.73" (19)
42" (1066.8)	44.50" (1130)	-	-	-	0.65" (16)	0.71" (18)	0.77" (20)	0.83" (21)
48" (1219.2)	50.80" (1290)	-	-	-	0.72" (18)	0.79" (20)	0.86" (22)	0.93" (24)
54" (1371.6)	57.10" (1450)	-	-	-	0.81" (21)	0.89" (23)	0.97" (25)	1.05" (27)

7.2 Tables: Sound Speed

7.2.1 Solids: Sound Speed Data

Material	Sound Speed		Sound Speed	
	Shear Wave (25(d))		Long. Wave (25(d))	
	ft/s	m/s	in/us	mm/us
Steel, 1% Carbon, hardened	10,335	3,150	0.2315	5.88
Carbon Steel	10,598	3,230	0.2319	5.89
Mild Steel	10,614	3,235	0.2319	5.89
Steel,1% Carbon	10,565	3,220	-	-
302 Stainless Steel	10,236	3,120	0.224	5.690
303 Stainless Steel	10,236	3,120	0.222	5.640
304 Stainless Steel	10,306	3,141	0.233	5.920
304L Stainless Steel	10,073	3,070	0.228	5.790
316 Stainless Steel	10,735	3,272	0.225	5.720
347 Stainless Steel	10,512	3,095	0.225	5.720
Aluminum	10,171	3,100	0.2488	6.32
Aluminum (rolled)	9,974	3,040	-	-
Copper	7,415	2,260	0.1835	4.66
Copper (annealed)	7,628	2,235	-	-
Copper (rolled)	7,448	2,270	-	-
CuNi (70%Cu 30%Ni)	8,334	2,540	0.1980	5.03
CuNi (90%Cu 10%Ni)	6,759	2,060	0.1579	4.01
Brass (Naval)	6,923	2,120	0.1744	4.43
Gold (hard-drawn)	3,937	1,200	0.1276	3.24
Inconel	9,909	3,020	0.2291	5.82
Iron (electrolytic)	10,630	3,240	0.2323	5.90
Iron (Armco)	10,630	3,240	0.2323	5.90
Ductile Iron	9,843	3,000	-	-
Cast Iron	8,203	2,500	0.1791	4.55
Monel	8,924	2,720	0.2106	5.35
Nickel	9,712	2,960	0.2217	5.63
Tin,rolled	5,479	1,670	0.1307	3.32
Tintanium	10,253	3,125	0.2402	6.10
Tungsten,annealed	9,482	2,890	0.2039	5.18
Tungsten,drawn	8,661	2,640	-	-
Tungsten,carbide	13,058	3,980	-	-
Zinc, rolled	8,005	2,440	0.1642	4.17
Glass, Pyrex	10,761	3,280	0.2209	5.61
Glass, heavy silicate flint	7,808	2,380		
Glass, light borate crown	9,318	2,840	0.2071	5.26
Nylon	3,772	1,150	0.0945	2.40
Nylon,6-6	3,510	1,070	-	-
Polyethylene (LD)	-	-	0.0909	2.31
Polyethylene (LD)	1,772	540	0.0764	1.94

PVC, CPVC	3,477	1,060	0.0945	2.40
Acrylic	4,690	1,430	0.1075	2.73
Asbestos Cement	-	-	0.0866	2.20
Tar Epoxy	-	-	0.0787	2.00
Mortar	-	-	0.0984	2.50
Rubber	-	-	0.00748	1.90

7.2.2 Water: Sound Speed

Sound Speed in Water at atmosphere pressure. Unit T (Deg °F) V (ft/s)

t	v	t	v	t	v	t	v
32.00	4600.72	77.00	4910.10	122.00	5060.70	167.00	5102.03
33.80	4617.13	78.80	4918.64	123.80	5063.98	168.80	5101.71
35.60	4633.20	80.60	4927.17	125.60	5067.59	170.60	5101.38
37.40	4648.62	82.40	4935.37	127.40	5070.54	172.40	5101.05
39.20	4664.04	84.20	4943.24	129.20	5073.49	174.20	5100.39
41.00	4678.81	86.00	4950.79	131.00	5076.44	176.00	5099.74
42.80	4693.24	87.80	4958.33	132.80	5079.07	177.80	5099.08
44.60	4707.35	89.60	4965.55	134.60	5081.69	179.60	5098.10
46.40	4721.46	91.40	4972.77	136.40	5083.99	181.40	5097.11
48.20	4734.91	93.20	4979.33	138.20	5086.29	183.20	5095.80
50.00	4748.03	95.00	4985.89	140.00	5088.25	185.00	5094.49
51.80	4760.83	96.80	4992.45	141.80	5090.22	186.80	5093.18
53.60	4773.29	98.60	4998.36	143.60	5091.86	188.60	5091.86
55.40	4785.76	100.40	5004.27	145.40	5093.50	190.40	5090.22
57.20	4797.57	102.20	5010.17	147.20	5095.14	192.20	5088.58
59.00	4809.06	104.00	5015.75	149.00	5096.46	194.00	5086.61
60.80	4820.54	105.80	5021.00	150.80	5097.44	195.80	5084.65
62.60	4831.69	107.60	5026.25	152.60	5098.43	197.60	5082.68
64.40	4842.52	109.40	5031.17	154.40	5099.41	199.40	5080.38
66.20	4852.69	111.20	5035.76	156.20	5100.07	201.20	5077.10
68.00	4863.19	113.00	5040.35	158.00	5100.72	203.00	5075.79
69.80	4873.03	114.80	5044.95	159.80	5101.38	204.80	5073.16
71.60	4882.55	116.60	5048.88	161.60	5101.71	206.60	5070.87
73.40	4892.06	118.40	5053.15	163.40	5101.71	208.40	5067.91
75.20	4901.25	120.20	5056.76	165.20	5102.03	210.20	5065.29

7.2.3 Liquids: Sound Speed Sound Speed in Liquids

Substance	Chemical Formula	All data given at 77°F (25°C) unless otherwise noted				
		Specific Gravity	Sound Speed		Kinematic Viscosity x10-6	
			ft/s	m/s	ft ² /s	m ² /s
Acetic anhydride (22)	(CH ₃ CO) ₂ O	1.082 (68°F)	3,871.4	1,180	8.274	0.769
Acetic acid, anhydride (22) (CH ₃ CO) ₂ O	(CH ₃ CO) ₂ O	1.082 (68°F)	3,871.4	1,180	8.274	0.769
Acetic acid, Nitrile	C ₂ H ₃ N	0.783	4,232.3	1,290	4.745	0.441
Acetic acid, Ethyl Ester (33)	C ₄ H ₈ O ₂	0.901	3,559.7	1,085	5.025	0.467
Acetic acid, Methyl Ester	C ₃ H ₆ O ₂	0.934	3,973.1	1,211	4.379	0.407
Acetone	C ₃ H ₆ O	0.791	3,851.7	1,174	4.293	0.399
Acetonitrile	C ₂ H ₃ N	0.783	4,232.3	1,290	4.745	0.441
Acetylacetone	C ₆ H ₁₀ O ₂	0.729	4,589.9	1,399	-	-
Acetylen Dichloride	C ₂ H ₂ CL ₂	1.26	3,330.1	1,015	4.304	0.400
Acetylen Tetrabromide (47)	C ₂ H ₂ Br ₄	2.966	3,369.4	1,027	-	-
Acetylen Tetrachloride (47)	C ₂ H ₂ CL ₄	1.595	3,763.1	1,147	12.438 (59°F)	1.156 (15°C)
Alcohol	C ₂ H ₆ O	0.789	3,960	1,207	15.02	1.396
Alkazene-13	C ₁₅ H ₂₄	0.86	4,320.9	1,317	-	-
Alkazene-25	C ₁₀ H ₁₂ CL ₂	1.20	4,288.1	1,307	-	-
2-Amino-Ethanol	C ₂ H ₇ NO	1.018	5,656.2	1,724	-	-
2-Aminotolidine (46)	C ₇ H ₉ N	0.999 (68°F)	5,308.4	1,618	47.279 (68°F)	4.394 (20°C)
4-Aminotolidine (46)	C ₇ H ₉ N	0.999 (113°F)	4,855.6	1,480	20.045 (122°F)	1.863 (50°C)
Ammonia (35)	NH ₃	0.771	5,672.6 (-27°F)	1,729 (-33°C) (d)	3.141 (-27°F)	0.292 (-33°C)
Amorphous Polyolefin	-	0.98	3158.2 (374°F)	962.6 (190°C)	286.000	26,600
t-Amyl Alcohol	C ₅ H ₁₂ O	0.81	3,950.1	1,204	47.064	4.374
Aminobenzene (41)	C ₆ H ₅ NO ₂	1.022	5,377.3	1,639	39.058	3.63
Aniline (41)	C ₆ H ₅ NO ₂	1.022	5,377.3	1,639	39.058	3.63
Argon (45)	Ar	1.400 (-306.4°F)	2798.6 (-306°F)	853 (-188°C)	-	-
Azine	C ₆ H ₅ N	0.982	4,642.4	1,415	10.673 (68°F)	0.992 (20°C)
Benzene (29,40,41)	C ₆ H ₆	0.879	4,284.8	1,306	7.65	0.711
Benzol (29,40,41)	C ₆ H ₆	0.879	4,284.8	1,306	7.65	0.711
Bromine (21)	Br ₂	2.928	2,916.7	889	3.475	0.323
Bromo-Benzene (46)	C ₆ H ₅ Br	1.522	3,838.6 (68°F)	1,170 (20°C)	7.456	0.693
1-Bromo-Butane (46)	C ₄ H ₉ Br	1.276 (68°F)	3,343.2 (68°F)	1,019 (20°C)	5.272 (59°F)	0.49 (15°C)
Bromo-Ethane (46)	C ₂ H ₅ Br	1.460 (68°F)	2,952.8 (68°F)	900 (20°C)	2.959	0.275
Bromoform (46,47)	CHBr ₃	2.89 (68°F)	3,011.8	918	7.037	0.654
n-Butane (2)	C ₄ H ₁₀	0.601 (32°F)	3,559.7 (23°F)	1,085 (-5°C)	-	-
2-Butanol	C ₄ H ₁₀ O	0.81	4,068.2	1,240	34.851	3.239
Sec-Butyl Alcohol	C ₄ H ₁₀ O	0.81	4,068.2	1,240	34.851	3.239
n-Butyl Bromide (46)	C ₄ H ₉ Br	1.276 (68°F)	3,343.2 (68°F)	1,019 (20°C)	5.272 (59°F)	0.49 (15°C)
n-Butyl Chloride (22,46)	C ₄ H ₉ CL	0.887	3,740.2	1,140	5.692 (59°F)	0.529 (15°C)
Tert Butyl Chloride	C ₄ H ₉ CL	0.84	3,228.3	984	6.95	0.646
Butyl Oleate	C ₂₂ H ₄₂ O ₂	-	4,606.3	1,404	-	-
2,3 Butylene Glycol	C ₄ H ₁₀ O ₂	1.019	4,808.8	1,484	-	-
Cadmium (7)	CD	-	7,341.5 (752°F)	2,237.7 (400°C)	14.579 (824°F)	1.355cp (440°C)
Carbinol (40,41)	CH ₄ O	0.791 (68°F)	3,530.2	1,076	7.478	0.695
Carbitol	C ₆ H ₁₄ O ₃	0.988	4,783.5	1,458	-	-
Carbon Dioxide (26)	CO ₂	1.101 (-98.6°F)	2,752.6 (-35°F)	839 (-37°C)	1.474 (-35°F)	0.137 (-37°C)
Carbon Disulphide	CS ₂	1.261 (71.6°F)	3,769.7	1,149	2.991	0.278

Carbon Tetrachloride (33, 35, 47)	CCl ₄	1.595 (68°F)	3038.1	929	6.531	0.607
Carbon tetrafluoride (14) (Freon 14)	CF ₄	1.75 (-302°F)	2,871.5 (-238°F)	875.2 (-150°C)	-	-
Cetane (23)	C ₁₆ H ₃₄	0.773 (68°F)	4,389.8	1,338	46.483	4.32
Chloro-Benezene	C ₆ H ₅ CL	1.106	4,176.5	1,273	7.768	0.722
1-Chloro-Butane (22,46)	C ₄ H ₉ CL	0.887	3,740.2	1,140	5.692 (59°F)	0.529 (15°C)
Chloro-DiFluoromethane (3) (Freon 22)	CHCLF ₂	1.491 (-156.2°F)	2,932.7 (-58°F)	893.9 (-50°C)	-	-
Chloroform (47)	CHCL ₃	1.489	3,211.9	979	5.918	0.55
1-Chloro-propane (47)	C ₃ H ₇ CL	0.892	3,471.1	1,058	4.067	0.378
Chlorotrifluoromethane (5)	C ₃ H ₇ CL	-	2,375.3 (-116°F)	724 (-82°C)	-	-
Cinnamaldehyde	C ₉ H ₈ O	1.112	5,098.4	1,554	-	-
Cinnamic aldehyde	C ₉ H ₈ O	1.112	5,098.4	1,554	-	-
Colamine	C ₂ H ₇ NO	1.018	5,656.2	1,724	-	-
o-Cresol (46)	C ₇ H ₈ O	1.047 (68°F)	5,055.8 (68°F)	1,541 (20°C)	46.16 (104°F)	4.29 (40°C)
m-Cresol (46)	C ₇ H ₈ O	1.034 (68°F)	4,923.1 (68°F)	1,500 (20°C)	64.334 (104°F)	5.979 (40°C)
Cyanomethane	C ₂ H ₃ N	0.783	4,232.3	1,290	4.745	0.441
Cyclohexane (15)	C ₆ H ₁₂	0.779 (68°F)	4,094.5	1,248	14.095 (63°F)	1.31 (17°C)
Cyclohexanol	C ₆ H ₁₂ O	0.962	4,770.3	1,454	0.764 (63°F)	0.071 (17(d))
Cyclohexanone	C ₆ H ₁₀ O	0.948	4,668.6	1,423	-	-
Decane (46)	C ₁₀ H ₂₀	0.730	4,107.6	1,252	13.55 (68°F)	1.26 (20°C)
1-Decene (27)	C ₁₀ H ₂₀	0.746	4,051.8	1,235	-	-
n-Decene (27)	C ₁₀ H ₂₀	0.746	4,051.8	1,235	-	-
Diacetyl	C ₄ H ₆ O	0.99	4,055.1	1,236	-	-
Diamylamine	C ₁₀ H ₂₃ N	-	4,120.7	1,256	8.5 (68°F)	-
1,2Dibromo-Ethane (47)	C ₂ H ₄ Br ₂	2.18	3,264.4	995	-	0.79 (20°C)
trans-1,2-Dibromoethene (47)	C ₂ H ₂ Br ₂	2.231	3,067.6	935	-	-
Diburtylphthalate	C ₈ H ₂₂ O ₄	-	4,619.4	1,408	-	-
Dichloro-t-Butyl Alcohol	C ₄ H ₈ Cl ₂ O	-	4,278.2	1,304	-	-
2,3Dichlorodioxane	C ₂ H ₆ Cl ₂ O ₂	-	4,563.6	1,391	-	-
Dichloedifluoromethane (3) (Freon12)	CCl ₂ F ₂	1.516 (104°F)	2,539.7	774.1	-	-
1,2Dichloro Ethane (47)	C ₂ H ₂ Cl ₂	1.253	3,914	1,193	6.563	0.61
cis1,2-Dichloro-ethene (3, 47)	CHCl ₂ F	1.284	3,481	1,061	-	-
trans1,2-Dichloro-Ethene (3,47)	C ₄ Cl ₂ F ₆	1.257	3,313.6	1,010	-	-
Dichloro-Fluoromethane (3) (Freon21)	C ₄ H ₈ Cl ₂	1.426 (32°F)	2,923.2 (32°F)	891 (0°C)	-	-
1-2-Dichlorohexafluoro-Cyclobutane (47)	CClF ₂ -CClF ₂	1.654	2,914.9	669	-	-
1-3-Dichloro-isobutane	C ₄ H ₁₀ O	1.14	4,002.6	1,220	-	-
Dichloro Methane (3)	C ₄ H ₁₀ O ₃	1.327	3,510.5	1,070	3.335	0.31
1,1-Dichloro-1,2,2,2 Tetra Fluoromethane	C ₆ H ₁₄ O ₃	1.455	2,182.7 (14°F)	665.3 (-10°C)	-	-
Diethyl Ether	C ₄ H ₉ NO	0.713	3,231.6	985	3.346	0.311
Diethylene Glycol	C ₄ H ₈ (NF ₂) ₂	1.116	5,203.4	1,586	-	-
Diethylene Glycol Monoethyl Ether	C ₄ H ₉ (NF ₂) ₂	0.988	4,783.5	1,458	-	-
Diethylenmide Oxide	C ₃ H ₆ (NF ₂) ₂	1.00	4,731	1,442	-	-
1,2-bis (DiFluoramino) Butane (43)	C ₁₀ H ₂₃ N	1.216	3,280.8	1,000	-	-
1,2-bis (DiFluoramino)-2-Methylpropane (43)	C ₂ H ₄ Br ₂	1.213	2,952.8	900	-	-

1,2-bis (DiFluoramino) Propane (43)	C ₂ H ₂ Br ₂	1.265	3,149.6	960	-	-
2,2-bis (Difluoromino) 2 Propane (43)	C ₃ H ₆ (NF ₂)	1.254	2920	890	-	-
2,2-Dihydroxydiethyl Ether	C ₄ H ₁₀ O ₃	1.116	5,2034	1,586	-	-
Dihydroxyethane	C ₂ H ₆ O ₂	1.113	5,439.6	1,658	-	-
1,3-Dimethyl-Benzene (46)	C ₈ H ₁₀	0.868 (59°F)	4,406.2 (68°F)	1,343 (20°C)	8.059 (59°F)	0.749 (15°C)
1,2-Dimethyl-Benzene (29,46)	C ₈ H ₁₀	0.897 (68°F)	4,368.4	1,331.5	9.716 (68°F)	0.903 (20°C)
1,4-Dimethyl-Benzene (46)	C ₈ H ₁₀	-	4,376.6 (68°F)	1,334v (20°C)	7.123	0.662
2,2Dimethyl-Butane (29,33)	C ₆ H ₁₄	0.649 (68°F)	3,540	1,079	-	-
Dimethyl Ketone	C ₃ H ₆ O	0.791	3,851.7	1,174	4.293	0.399
Dimethylpentane (47)	C ₇ H ₁₆	0.674	3,487.5	1,063	-	-
Dimethylphthalate	C ₈ H ₁₀ O ₄	1.2	4,799.9	1,463	-	-
Diiodo-Methane	CH ₂ I ₂	3.235	3,215.2	980	-	-
Dioxane	C ₄ H ₈ O ₂	1.033	4,514.4	1,376	-	-
Dodecane (23)	Cl ₂ H ₂₆	0.749	4,196.2	1,279	19.368	1.80
1,2Ethanediol	C ₂ H ₆ O ₂	1.113	5,439.6	1,658	-	-
Ethanenitrile	C ₂ H ₃ N	0.783	4,232.3	1,290	4.745	0.441
Ethanoic Anhydride (22)	(CH ₃ CO) ₂ O	1.082	3,871.4	1,180	8.274	0.769
Ethanol	C ₂ H ₆ O	0.789	3,690	1,207	14.956	1.39
Ethanol Amide	C ₂ HNO	1.018	5,656.2	1,338 (20°C)	-	-
Ethoxyethane	C ₄ H ₁₀ O	0.713	3,231.6	900 (20°C)	3.346	0.311
Ethyl Acetate (33)	C ₄ H ₈ O ₂	0.901	3,559.7	876 (20°C)	5.263	0.489
Ethyl Alcohol	C ₂ H ₆ O	0.789	3,960	890	15.020	1.396
Ethyl Benzene (46)	C ₈ H ₁₀	0.867 (68°F)	4,389.8 (68°F)	1,586	8.575 (63°F)	0.797 (17°C)
Ethyl Bromide (46)	C ₂ H ₅ Br	1.456 (68°F)	2,952.8 (68°F)	1,658	2.959 (68°F)	0.275 (20°C)
Ethyl iodide (46)	C ₂ H ₅ I	1.950 (68°F)	2874 (68°F)	1,343 (20°C)	3.12	0.29
Ether	C ₄ H ₁₀ O	0.713	3231.6	985	3.346	0.311
Ethyl Ether	C ₄ H ₁₀ O	0.713	3231.6	985	3.346	0.311
Ethylene Bromide (47)	C ₂ H ₄ Br ₂	2.18	3264.4	995	8.5	0.79
Ethylene Chloride (47)	C ₂ H ₄ Cl ₂	1.253	3914	1,193	6.563	0.61
Ethylene Glycol	C ₂ H ₆ O ₂	1.113	5439.6	1,658	185.158 (68°F)	17.208 (20°C)
d-Fenochone	C ₁₀ H ₁₆ O	0.974	4330.7	1,320	2.367	0.22
d-2-Fenechanone	C ₁₀ H ₁₆ O	0.974	4330.7	1,320	2.367	0.22
Fluorine	F	0.545 (-289.4°F)	1322.2 (-225°F)	403 (-143(d))	-	-
Fluoro-Benzene (46)	C ₆ H ₅ F	1.024 (68°F)	3900.9	1,189	6.283 (68°F)	0.584 (20°C)
Formaldehyde, Methylester	C ₂ H ₄ O ₂	0.974	3697.5	1,127	-	-
Formamide	CH ₃ NO	1.134 (68°F)	5321.5	1,622	31.311	2.91
Formic Acid, Amide	CH ₃ NO	1.134 (68°F)	5321.5	1,622	31.311	2.91
Freon R12	-	-	2540	774.2	-	-
Furfural	C ₅ H ₄ O ₂	1.157	4737.5	1,444	-	-
Furfuryl Alcohol	C ₅ H ₆ O ₂	1.135	4757.5	1,450	-	-
Fural	C ₅ H ₄ O ₂	1.157	4737.5	1,444	-	-
2-Furaldehyde	C ₅ H ₄ O ₂	1.157	4737.5	1,444	-	-
2-Furancarboxaldehyde	C ₅ H ₄ O ₂	1.157	4737.5	1,444	-	-
2-Furyl-Methanol	C ₅ H ₆ O ₂	1.135	4757.2	1,450	-	-
Gallium	Ga	6.095	9416 (86°F)	2,870 (30°C)	-	-
Glycerin	C ₃ H ₈ O ₃	1.26	6246.7	1,904	-	757.1
Glycerol	C ₃ H ₈ O ₃	1.26	6246.7	1,904	-	757.1
Glycol	C ₂ H ₆ O ₂	1.113	5439.6	1658	8,081.836	-
50%Glycol/50%h2O	-	-	5,177	1,578	8,081.836	-
Helium (45)	He ₄	0.125 (-516.2°F)	600.4 (-452°F)	183 (-269°C)	269	0.025
Heptane (22,23)	C ₇ H ₁₆	0.684 (408.2°F)	3,710.6	1,131	6.434 (68°F)	0.598 (209°C)
n-Heptane (29,33)	C ₇ H ₁₆	0.684 (68°F)	3,871.3	1,180	-	-

Hexachloro-Cyclopentadiene (47)	C ₅ Cl ₆	1.7180	3,773	1,150	-	-
Hexadecane (23)	C ₁₆ H ₃₄	0.773 (68°F)	4,389.8	1,338	46.483 (68°F)	4.32 (20°C)
Hexalin	C ₆ H ₁₂ O	0.962	4,770.3	1,454	760.882 (63°F)	70.69 (17°C)
Hexane (16,22,23)	C ₆ H ₁₄	0.659	3,648.3	1,112	4.798	0.446
n-Hexane (29,33)	C ₆ H ₁₄	0.649 (68°F)	3,540	1,079	-	-
2,5Hexanedione	C ₆ H ₁₀ O ₂	0.729	4,589.9	1,399	-	-
n-Hexanol	C ₆ H ₁₄ O	0.819	4,265.1	1,300	-	-
Hexahydrobenzene (15)	C ₆ H ₁₂	0.779	4,094.5	1,248	14.095 (63°F)	1.31 (179°C)
Hexahydrophenol	C ₆ H ₁₂ O	0.962	4,770.3	1,454	-	-
Hexamethylene (15)	C ₆ H ₁₂	0.779	4,094.5	1,248	14.095 (63°F)	1.31 (17°C)
Hydrogen (45)	H ₂	0.071 (-492.8°F)	3,894.4 (-429°F)	1,187 (-256°C)	0.032 (-429°F)	0.003 (-256°C)
2-Hydroxy-Toluene (46)	C ₇ H ₈ O	1.047 (68°F)	5,055.8 (68°F)	1,541 (20°C)	46.16 (104°F)	4.29 (40°C)
3-Hydroxy-Toluene (46)	C ₆ H ₅ l	1.034 (68°F)	4,921.3 (68°F)	1,500 (20°C)	64.334 (104°F)	5.979 (40°C)
Iodo-Benzene (46)	C ₂ H ₅ l	1.823	3,654.9 (68°F)	1,114 (20(d))		0.954
Iodo-Ethane (46)	CH ₃ l	1.950 (68°F)	2,874 (68°F)	876 (20°C)	3.12	0.29
Iodo-Methane	C ₆ H ₁₂ O	2.28 (68°F)	3,208.7	978	2.27	0.211
Isobutylacetate (22)	He ₄	-	3,871.4 (81°F)	1,180 (27°C)	-	-
Isobutanol	C ₄ H ₁₀ O	0.81 (68°F)	3,976.4	1,212	-	-
Iso-Butane	-	-	4002	1,219.8	-	-
Isopentane (36)	C ₅ H ₁₂	0.62 (68°F)	3,215.2	980	3.658	0.34
Isopropano (46)	C ₃ H ₈ O	0.758 (68°F)	3,838.6 (68°F)	1,170 (20°C)	29.245	2.718
Isopropyl Alcohol (46)	C ₃ H ₈ O	0.758 (68°F)	3,838.6 (68°F)	1,170 (20°C)	29.245	2.718
Kerosene	-	0.81	4,343.8	1,324	-	-
Ketohexamethylene	C ₆ H ₁₀ O	0.948	4,668.6	1,423	-	-
Lithium Fluoride (42)	LiF	-	8,152.9 (1652°F)	2,485 (900°C)	-	-
Mercury (45)	Hg	13.594	4,753.9 (75°F)	1,449 (24°C)	1.226	0.114
Mesityloxide	C ₆ H ₁₆ O	0.85	4,297.9	1,310	-	-
Methane (25,28,38,39)	CH ₄	0.162 (-192.2°F)	1,328.7 (-128°F)	405 (-89°C)	-	-
Methano (40,41)	CH ₄ O	0.791 (68°F)	3,530.2	1,076	7.748	0.695
Methyl Acetate	C ₃ H ₆ O ₂	0.934	3,973.1	1,211	4.379	0.407
o-Methylaniline (46)	C ₇ H ₉ N	0.999 (68°F)	5,308.4	1,618	47.279 (68°F)	4.394 (20°C)
4-Methylaniline (46)	C ₇ H ₉ N	0.966 (45(d))	4,855.6	1,480	20.095 (122°F)	1.863 (50°C)
Methyl alcohol (40,44)	CH ₄ O	0.791 (20(d))	3,530.2	1,076	7.478	0.695
Methyl Benzene (16,52)	C ₇ H ₈	0.867	4,357 (68°F)	1,328 (20°C)	7.144	0.644
2-Methyl-Butane (36)	C ₅ H ₁₂	0.62 (68°F)	3,215.2	980	3.658	0.34
Methy Carbinol	C ₂ H ₆ O	0.789	3,960	1,207		1.396
Methy-Chloroform (47)	C ₂ H ₃ Cl ₃	1.33	3,231.6	985	9.705 (68°F)	0.902 (20°C)
Methyl-Cyanide	C ₂ H ₃ N	0.783	4,232.3	1,290	4.745	0.441
3-Methyl Cyclohexanol	C ₇ H ₁₄ O	0.92	4,593.2	1,400	-	-
Oil, Diesel	-	0.80	4,101	1,250	-	-
Oil, Field Gravity	-	0.99	4,872	1,485	-	-
Oil (Lubricating x200)	-	-	5,019.9	1,530	-	-
Oil (Olive)	-	0.912	4,694.9	1,431	1,076.36	100
Oil (Peanut)	-	0.936	4,783.5	1,458	-	-
Oil (Sperm)	-	0.88	4,724.2	1,440	-	-
Oil, 6	-	-	4,951 (72°F)	1,509 (22°C)	-	-
2,2-Oxydiethanol	CH ₁₀ O ₃	1.116	5,203.4	1,586	-	-
Oxygen (45)	O ₂	1.155 (-366.8°F)	3,123.4 (-303°F)	952 (-186°C)	1.861	0.173
Pentachloro-Ethane (47)	C ₂ HCl ₅	1.687	3,549.4	1,082	-	-
Pentalin (47)	C ₂ HCl ₅	1.687	3,549.4	1,082	-	-
Pentane (36)	C ₅ H ₁₂	0.626 (68°F)	3,346.5	1,020	3.905	0.363
n-Pentane (47)	C ₅ H ₁₂	0.557	3,300.5	1,006	4.413	0.41
Perchlorocyclopentadiene (47)	C ₅ Cl ₆	1.718	3,773	1,150	-	-
Perchloro-Ethylene (47)	C ₂ Cl ₄	1.632	3,399	1,036	-	-

Perfluoro-1-Hepten (47)	C ₇ F ₁₄	1.67	1,912.7	583	-	-
Perfluoro-n-Hexane (47)	C ₆ H ₁₄	1.672	1,666.7	508	-	-
Phene (29,40,41)	C ₆ H ₆	0.879	4,284.8	1,306	7.65	0.711
b-Phenyl Acrolein	C ₉ H ₈ O	1.112	5,098.4	1,554	-	-
Phenylamine (41)	C ₆ H ₅ NO ₂	1.022	5,377.3	1,639	39.058	3.63
Phenyl Bromide (46)	C ₆ H ₅ Br	1.522	3,838.6 (68°F)	1,170 (20°C)	7.465	0.693
Phenyl chloride	C ₆ H ₅ Cl	1.106	4,176.5	1,273	7.768	0.722
Phenyl Iodide (46)	C ₆ H ₅ I	1.823	3,654.9 (68°F)	1,114 (20°C)	10.265 (59°F)	0.954 (15°C)
Phenyl Methane (16,52)	C ₇ H ₈	0.867 (68°F)	4,357 (68°F)	1,328 (20°C)	6.929	0.644
3-Phenylpropenal	C ₉ H ₈ O	1.112	5,098.4	1,554	-	-
Phthalardione	C ₈ H ₄ O ₃	-	3,691 (306°F)	1,125 (152°C)	-	-
Phthalic Acid, Anhydride	C ₈ H ₄ O ₃	-	3,691 (306°F)	1,125 (152°C)	-	-
Phthalicanhydride	C ₈ H ₄ O ₃	-	3,691 (306°F)	1,125 (152°C)	-	-
Pimelicketone	C ₆ H ₁₀ O	0.948	4,668.6	1,423	-	-
Plexiglas, Lucite, Acrylic	-	-	8,698	2,651	-	-
Polyterpene Resin	-	0.77	3,608.4 (374°F)	1,099.8 (190°C)	419,500	39,000
Potassium Bromide (42)	KBr	-	3,835.3 (1652°F)	1,169 (900°C)	7.693 (1652°F)	715CP (900°C)
Potassium Fluoride (42)	KF	-	5,879.3 (1652°F)	1,792 (900°C)	-	-
Potassium Iodide (42)	KI	-	3,231.6 (1652°F)	958 (900°C)	-	-
Potassium Nitrate (48)	KNO ₃	1.859 (665.6°F)	5,709 (666°F)	1,740.1 (352°C)	12.804 (621°F)	1.19 (327°C)
Propane (2,13) (-45°to-130°)	C ₃ H ₈	0.585 (-113°F)	3,290.6 (-46°F)	1,003 (-45°C)	-	-
1,2,3-Propanetriol	C ₃ H ₈ O ₃	1.26	6,246.7	1,904	-	000757
2-Propanol (46)	C ₃ H ₈ O	0.785 (68°F)	3,838.6 (68°F)	1,170 (20°C)	29.245	2.718
2-Propanone	C ₃ H ₆ O	0.791	3,851.7	1,174	4.293	0.399
Propene (17,18,35)	C ₃ H ₆	0.563 (-55.4°F)	3,159.4 (9°F)	963 (-13°C)	-	-
n-Propyl-Acetate (22)	C ₅ H ₁₀ O ₂	-	4,199 (36°F)	1,280 (2°C)	-	-
n-Propyl-Alcohol	C ₃ H ₈ O	0.78 (68°F)	4,009.2 (68°F)	1,222 (20°C)	27.427	2.549
Propylchloride (47)	C ₃ H ₇ Cl	0.892	3,471.1	1,058	4.067	0.378
Propylene (17,18,35)	C ₃ H ₆	0.536 (-55.4°F)	3,159.4 (9°F)	963 (-13°C)	-	-
Pyridne	C ₆ H ₅ N	0.982	4,642.4	1,415	10.673 (68°F)	0.992 (20°C)
Refrigerant11 (3,4)	CCl ₃ F	1.49	2,717.5 (32°F)	828.3 (0°C)	-	-
Refrigerant12(3)	CCl ₂ F ₂	1.516 (-104°F)	2,539.7 (-40°F)	774.1 (-40°C)	-	-
Refrigerant14 (14)	CF ₄	1.75 (-302°F)	2,871.5 (-238°F)	875.24 (-150°C)	-	-
Refrigerant21 (3)	CHCl ₂ F	1.426 (32°F)	2,923.2 (32°F)	891 (0°C)	-	-
Refrigerant22 (3)	CHClF ₂	1.491 (-156.2°F)	2,932.7 (122°F)	893.9 (50°C)	-	-
Refrigerant113 (3)	CCl ₂ F-CClF ₂	1.563	2,571.2 (32°F)	783.7 (0°C)	-	-
Refrigerant114(3)	CClF ₂ -CClF ₂	1.455	2,182.7 (14°F)	665.3 (-10°C)	-	-
Refrigerant115(3)	C ₂ ClF ₅	-	2,153.5 (-58°F)	656.4 (-50°C)	-	-
RefrigerantC318(3)	C ₄ F ₈	1.62 (-68°F)	1,883.2 (41°F)	574 (-10°C)	-	-
Selenium (8)	Se	-	3,517.1 (482°F)	1,072 (250°C)	-	-
Silicone(30cp)	-	0.993	3,248	990	322.8	30
Sodiumfluoride(42)	NaF	0.877	6,830.7 (1832°F)	2,082 (1000°C)	-	-
Sodiumfluoride(48)	NaNO ₃	1.884 (636.8°F)	5,785.1 (637°F)	1,763.3 (336°C)	14.74 (637 °F)	1.37 (336°C)
Sodiumfluoride(48)	NaNO ₂	1.805 (557.6°F)	6,157.5 (558°F)	1,876.8 (292°C)	-	-
Solvesso#3	-	0.877	4,494.8	1,370	-	-
Spiritofwine	C ₂ H ₆ O	0.789	3,960	1,207	15.02	1.397
Sulfur (7,8,10)	S	-	3,861.5 (482°F)	1,177 (250°C)	-	-
SulfueicAcid (1)	H ₂ SO ₄	1.841	4,126	1,257.6	120.081	11.16
Tellurium (7)	Te	-	3,251.3 (842°F)	991 (450°C)	-	-
1,1,2,2-Tetrabromo-Ethane (47)	C ₂ H ₂ Br ₄	2.966	3,369.4	1,027	-	-
1,1,2,2-Tetrachloro-Ethane (67)	C ₂ H ₂ Cl ₄	1.595	3,763.4	1,147	12.438 (59°F)	1.156 (15°C)
Tetrachloroethane (46)	C ₂ H ₂ Cl ₄	1.553 (68°F)	3,838.6 (68°F)	1,170 (20°C)	12.804	1.19
Tetrachloro-Ethene (47)	C ₂ Cl ₄	1.632	3,399	1,036	-	-
Tetrachlor-Methane (33,47)	CCl ₄	1.595 (68°F)	3,038.1	926	6.531	0.607

Tetradecane (46)	C ₁₄ H ₃₀	0.763 (68°F)	4,366.8 (68°F)	1,331 (20°C)	30.773 (68°F)	2.86 (20°C)
Tetraethylene Glycol	C ₈ H ₁₈ O ₅	1.123	5,203.4	1,568	-	-
Tetrafluoro-Methane (14) (Freon14)	CF ₄	1.75 (-302°F)	2,871.5 (-238°F)	875.24 (-150°C)	-	-
Tetrahydro-1,4-isoxazine	C ₄ H ₉ NO	1.000	4,731	1,442	-	-
Toluene (16,52)	C ₇ H ₈	0.867 (68°F)	4,357 (68°F)	1,328 (20°C)	6.929	0.644
o-Toluidine (46)	C ₇ H ₉ N	0.999 (68°F)	5,308.4	1,618	47.279 (68°F)	4.394 (20°C)
p-Toluidine (46)	C ₇ H ₉ N	0.966 (113°F)	4,855.6	1,480	20.053 (122°F)	1.863 (50°C)
Toluol	C ₇ H ₈	0.866	4,291.3	1,308	6.24	0.58
Tribromo-Methane (46,47)	CHBr ₃	2.89 (68°F)	3,011.8	918	7.037	0.645
1,1,1-Trichloro-Ethane (47)	C ₂ H ₃ Cl ₃	1.33	3,231.6	985	9.705 (68°F)	0.902 (20°C)
Trichloro-Ethene (47)	C ₂ HCl ₃	1.464	3,372.7	1,028	-	-
Trichloro-Fluoromethane (3)(Freon11)	CCl ₃ F	1.49	2,171.5 (32°F)	828.3 (0°C)	-	-
Trichloro-Methane (47)	CHCl ₃	1.489	3,211.9	979	5.918	0.55
1,1,2-Trichloro- 1,2,2,2-Trifluoro-Ethane	CCl ₂ F-CClF ₂	1.563	2,571.2(32°F)	783.7 (0°C)	-	-
Triethyl-Amine (33)	C ₆ H ₁₅ N	0.726	3,684.4	1,123	-	-
Triethyleneglycol	C ₆ H ₁₄ O ₄	1.123	5,275.6	1,608	-	-
1,1,1-Trifluoro-2- Chloro-2-Bromo-Ethane	C ₂ HClBrF ₃	1.869	2,273.6	693	-	-
1,2,2-Trifluorotrichloro- Ethane (Freon113)	CCl ₂ -CClF ₂	1.563	2,571.2 (32°F)	783.7 (0°C)	-	-
d-1,3,3 C10H16O -Trimethylnorcamphor	-	0.947	4,330.7	1,320	2.367	0.22
Trinitrotoluene (43)	C ₇ H ₅ (NO ₂) ₃	1.64	5,282.2 (178°F)	1,610 (81°C)	-	-
Turpentine	-	0.88	4,117.5	1,255	15.064	1.4
Unisis800	-	0.87	4,416	1,346	-	1.00
Water, Distilled (49,50) Water, Sea	H ₂ O	0.996	4,914.7	1,498	10.76	0.695
WoodAlcohol (40,41)	D ₂ O	-	4,593	1,400	-	-
Xenon (45)		1.025	5,023	1,531	10.76	1.00
m-Xylene (46)	CH ₄ O	0.791 (68°F)	3,530.2	1,076	7.478	0.695
o-Xylene (29,46)	Xe	-	2,067 (-164°F)	630 (-109°C)	-	-
P-xylene (46)	C ₈ H ₁₀	0.868 (59°F)	4,406.2 (68°F)	1,343(20°C)	8.059 (59°F)	0.749 (15°C)
Xylenhexafluoride	C ₈ H ₁₀	0.897 (68°F)	4,368.4	1,331.5	9.716 (68°F)	0.903 (20°C)
Zinc (7)	C ₈ H ₁₀	-	4,376.6 (68°F)	1,334 (20°C)	7.123	0.662
1,1,1-Trifluoro-2-Chloro- 2-Bromo-Ethane	C ₂ H ₄ F ₆	1.37	2,883.9	879	6.595	0.613
1,2,2-Trifluorotrichloro Ethane (Freon113)	Zn	-	10,820.2 (842°F)	3,298 (450°C)	-	-

8 Parts Descriptions



Fig 21: Standard
(Without sensors)



Fig 22: Customized
(With sensor)



TEKMATION LLC reserves the right to change the designs and/or materials of its products without notice. The contents of this publication are the property of TEKMATON and cannot be reproduced by any other party without written permission. All rights reserved. Copyright © 2022 TEKMATON LLC
DOC:TEKTIPS/MIU/230607/1200A/02.2



www.tek-trol.com

Tek-Trol LLC

796 Tek Drive Crystal Lake, IL 60014, USA

Sales: +1 847-857-6076

Tek-DPro Flow Solutions

PO Box 121 Windsor,
Colorado 80550, USA
Sales: +1 847-857-6076

Tek-Trol Solutions BV

Florijnstraat 18, 4879 AH
Etten-Leur, Netherlands
Sales: +31 76-2031908

Tek-Trol Middle East FZE

SAIF Zone, Y1-067, PO BOX No. 1125,
Sharjah, UAE
Sales: +971-6526-8344

Support: +1 847-857-6076

Email: tektrol@tek-trol.com

www.tek-trol.com

Tek-Trol is a fully owned subsidiary of TEKMATON LLC. We offer our customers a comprehensive range of products and solutions for process, power and oil & gas industries. Tek-Trol provides process measurement and control products for Flow, Level, Temperature & Pressure Measurement, Control Valves & Analyzer systems. We are present in 15 locations globally and are known for our knowledge, innovative solutions, reliable products and global presence.

Flow | Level | Temperature | Pressure | Valves | Analyzers | Accessories | TekValSys