

"BA-475B" *

1/4" - 4"

BRASS BALL VALVE***
TWO-PIECE, FULL-PORT
600 WOG (1/4"-3") 400 WOG (4")
THREADED ENDS*
BLOW-OUT PROOF STEM

MSS-SP110
ASME A112.4.14



1/4" through 2" Only

MATERIALS LIST

ITEM	PART	MATERIALS	ASTM SPEC.
1	Body	Brass, Forged	B283
2	Tailpiece	Brass, Forged	B283
3	Ball	CP Brass 3/8" - 1-1/4"	B283
		CP Brass, Cast 1-1/2 - 3"	B584
4	Ball Seal	PTFE	Commercial
5	Stem	Brass	B124
6	O-Ring	Buna-N	D2006
7	ThrustWasher	PTFE	Commercial
8	Gland Nut	Brass	B16
9	Packing	PTFE	Commercial
10	Handle	Zinc Plated Steel	Commercial
11	Handle Nut	Zinc Plated Steel	Commercial
****12	Body Seal	PTFE	Commercial

*Also Available BA-475B-LL
 (Locks only in closed position)
 ** Not Suitable For Ammonia Service
 ***Not intended for use in potable water.
 ****4" Valve Only

PRESSURE - TEMPERATURE CHART

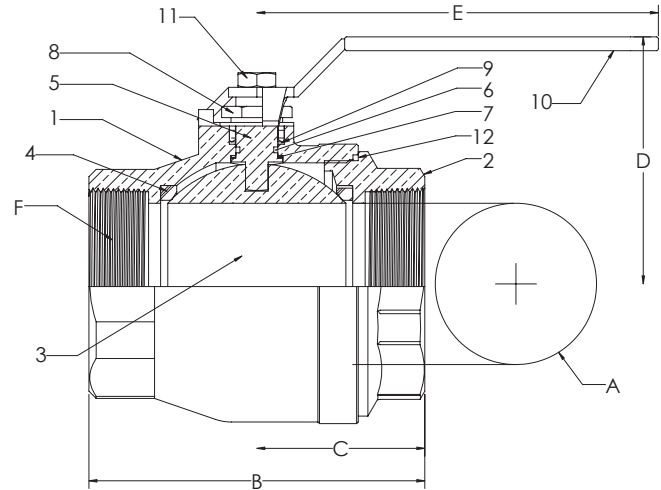
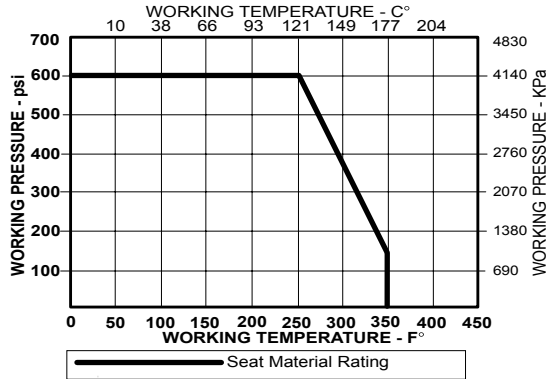

DIMENSIONS

Valve Size	UNITS	1/4"	3/8"	1/2"	3/4"	1"	1-1/4"	1-1/2"	2"	2-1/2"	3"	4"
A	INCHES	0.39	0.39	0.51	0.76	1.00	1.26	1.50	2.00	2.48	2.95	3.94
	mm	9.9	9.9	12.7	19.3	25	32.0	38.1	51.0	63	74.9	100.1
B	INCHES	1.87	1.87	2.25	2.62	3.06	3.5	3.75	4.38	5.16	6	8.2
	mm	47	47	57	67	78	89	95	111	131.1	152.4	208.3
C	INCHES	0.95	0.95	1.12	1.31	1.91	2.21	1.87	2.19	2.58	3	4.11
	mm	24	24	61	33	49	56	47	56	65.5	76.2	104.4
D	INCHES	1.42	1.42	1.46	1.93	2.1	2.33	2.52	2.96	3.94	4.37	5.93
	mm	36	36	37	49	53	59	64	75	100.1	111	150.6
E	INCHES	3.14	3.14	3.14	4.35	4.35	5.00	5.00	6.90	7.87	7.87	9.65
	mm	80	80	80	110	110	127	127	175	199.9	199.9	245.1
F	THREAD SIZE	1/4" NPT	3/8" NPT	1/2" NPT	3/4" NPT	1" NPT	1-1/4" NPT	1-1/2" NPT	2" NPT	2-1/2" NPT	3" NPT	4" NPT
Cv		12	12	18	40	72	112	161	287	307	323	584
TORQUE	in-lb	16	16	19	58	69	89	124	210	445	563	1080
	N.m	1.8	1.8	2.1	6.5	7.8	10	14	24	50	64	122
WEIGHT	lbs	0.33	0.34	0.47	0.89	1.24	1.66	2.34	4.94	7.4	10.47	34
	Kg	0.149	0.155	0.213	0.403	0.565	0.755	1.064	2.245	3.35	4.75	16

Rev. 29

The information presented on this sheet is correct at the time of publication. Milwaukee Valve reserves the right to change design, and/or material specifications without notice. For the Installation, Operation and Maintenance Manual (IOM) see the Technical/Service Information section on our website. For the most current information access www.milwaukeevalve.com

